

WORKSHOP SPECIFICATIONS

# XL<sup>3</sup> S 160

DISTRIBUTION CABINETS



**XL<sup>3</sup> S 160** cabinets are “fully modular” cabinets, from 2 to 8 rows of **24 modules** and from 4 to 8 rows of **36 modules** supplied ready to use (rails and multi-row faceplates mounted).

They are available in 2 metallic versions: **surface mounting** and **flush-mounting** cabinets.

They can receive, modular devices, DPX<sup>3</sup> 160, DRX 125 MCCBs and Vistop isolating switches up to 160 A.

XL<sup>3</sup> S 160 has been designed to make wiring and connection easier with removable and adjustable DIN rails.

It is supplied with multi-row faceplates.

Particular attention must be paid on presentation pictures that do not include personal protective equipment (PPE). PPE are legal and regulatory obligations.

In accordance with its continuous improvement policy, Legrand reserves the right to change the specifications and illustrations without notice. All illustrations, descriptions and technical information included in this document are provided as indications and cannot be held against Legrand.

# CONTENTS

## Surface mounting cabinets

Preparing surface mounting cabinets .....	4 to 9
Mounting devices .....	10-11
Wiring and connection .....	12-13
Accessories mounting .....	14-15

## Flush-mounting cabinets

Preparing flush-mounting cabinets.....	16 to 25
Mounting devices .....	26-27
Wiring and connection .....	28-29
Accessories mounting .....	30-31

Accessories and spare-parts.....	32-33
----------------------------------	-------

# SURFACE MOUNTING CABINETS

XL<sup>3</sup> S 160 cabinets are ready to use cabinets with high capacity (up to 288 modules) and optimized dimensions for electrical distribution up to 160 A.

They have been designed in order to simplify the protection equipment installation and the wiring operations.

- Adjustable DIN rail on 3 positions,
- Removable chassis,
- Flexibility in the choice of the terminal blocks.

## SPECIFICATIONS

- Class I metal cabinet
- Rated peak withstand current I<sub>pk</sub>: 34 kA
- IP 30 without door, IP 40 with door
- IK 07 without door, IK 08 with door
- Door opening angle: 130°
- Conforming to standard IEC 61439-2
- Can take devices up to 160 A
- Colour RAL 9003
- Maximum rated voltage (U<sub>e</sub>) up to 500 V ~
- Rated insulation voltage: (U<sub>i</sub>) 1000 V ~
- Rated impulse withstand voltage (U<sub>imp</sub>):  
8 kV (moulded case)  
4 kV (modular)
- Supplied complete with rails, multi-rows faceplates, knock-out cable entry and support for terminal blocks (neutral and earth)

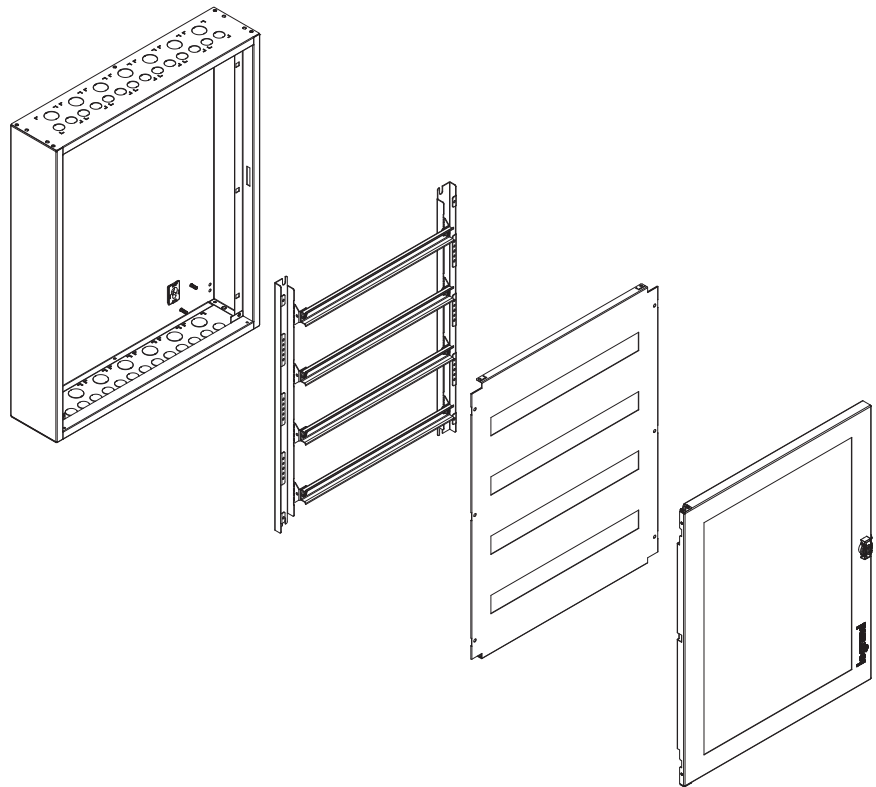

## PRODUCTS SELECTION



The XL<sup>3</sup> S 160 range contains “fully modular” cabinets, from 2 to 8 rows of 24 modules and from 4 to 8 rows of 36 modules.

**i** Possibility to choose a special colour from a panel of 197 shades: RAL only possible on metal parts.  
For any request on technical possibilities and extra costs, please contact the technical support: [support-technique-edia.fr-lgs@legrand.fr](mailto:support-technique-edia.fr-lgs@legrand.fr)

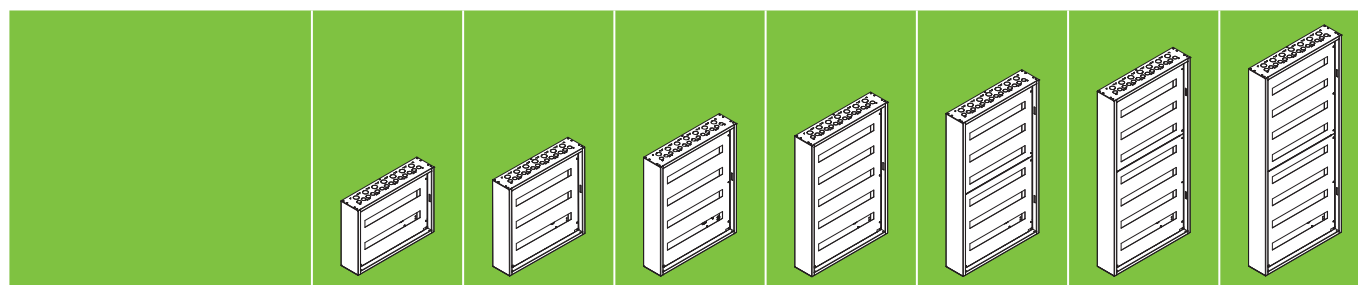
### THE XL<sup>3</sup> S 160 SURFACE MOUNTING CABINET RANGE



#### 24 MODULES PER ROW

<b>Cat. Nos</b>	3 372 02	3 372 03	3 372 04	3 372 05	3 372 06	3 372 07	3 372 08
<b>Number of rows</b>	2	3	4	5	6	7	8
<b>Number of modules</b>	48	72	96	120	144	168	192
<b>Metal door (flat)</b> 	3 372 52	3 372 53	3 372 54	3 372 55	3 372 56	3 372 57	3 372 58
<b>Glass door (flat)</b> 	3 372 72	3 372 73	3 372 74	3 372 75	3 372 76	3 372 77	3 372 78

#### 36 MODULES PER ROW

<b>Cat. Nos</b>	-	-	3 372 14	3 372 15	3 372 16	3 372 17	3 372 18
<b>Number of rows</b>	-	-	4	5	6	7	8
<b>Number of modules</b>	-	-	144	180	216	252	288
<b>Metal door (flat)</b> 	-	-	3 372 64	3 372 65	3 372 66	3 372 67	3 372 68
<b>Glass door (flat)</b> 	-	-	3 372 84	3 372 85	3 372 86	3 372 87	3 372 88

## Preparing the cabinets for use

The XL<sup>3</sup> S 160 cabinets are supplied in a cardboard packaging, reusable for delivery to the site.



The cabinet is supplied with a bag containing 2 screws to fix the terminal block supports, 2 terminal block supports, 4 blanking plates for keyhole, 8 covers (plugs) for joining /combination and 4 caps for the hinge holes.

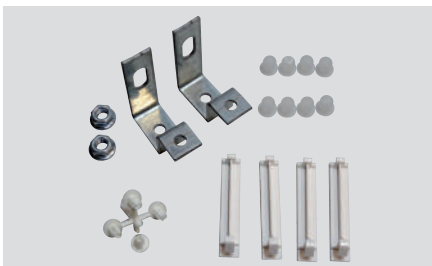

### 1 DIMENSIONS

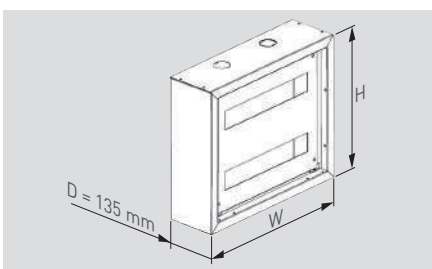

Useful depth: 102 mm

Cat. Nos	H (mm)	Useful H	W (mm)	Useful W
24 mod.	3 372 02	440	400	
	3 372 03	590	550	
	3 372 04	740	700	
	3 372 05	890	850	595
	3 372 06	1040	1000	
	3 372 07	1190	1150	
36 mod.	3 372 08	1340	1300	
	3 372 14	740	700	
	3 372 15	890	850	
	3 372 16	1040	1000	810
	3 372 17	1190	1150	
3 372 18	1340	1300		

### 2 FIXING

The XL<sup>3</sup> S 160 surface mounting cabinets can be fixed on a wall or a partition. This can be realized with the internal fixing points or with mounting lugs.

#### Internal fixing

Each cabinet has 4 internal fixing points. The shape of the knocked out holes is used to attach and detach the cabinets.



1- Knock out the keyhole shaped holes.



2- Fix the cabinet by using 4 screws (Ø 6mm minimum) and 4 washers.



**i** In case of cabinet joining, it is recommended to use the mounting lugs (see page 5).

#### Internal fixing centres

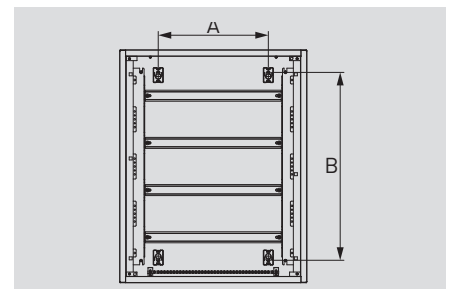

Cat. Nos	A (mm)	B (mm)
24 mod.	3 372 02	297
	3 372 03	447
	3 372 04	597
	3 372 05	747
	3 372 06	897
	3 372 07	1047
	3 372 08	1197
	36 mod.	3 372 14
3 372 15		747
3 372 16		897
3 372 17		1047
3 372 18		1197

## 2 FIXING (CONTINUED)

### ■ Fixing with wall-mounting lugs

The wall-mounting lugs Cat. No 3 374 00 can be installed in horizontal or vertical position.



1- Screw the lug in the required position with the 2 screws + nuts supplied in the pack.



View inside the cabinet:



2- Fix the cabinet on the wall by using 4 screws Ø 6mm.

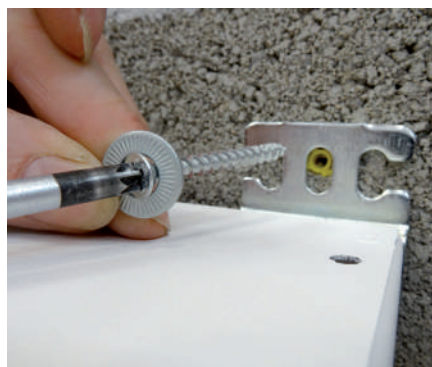

### ■ External fixing centres

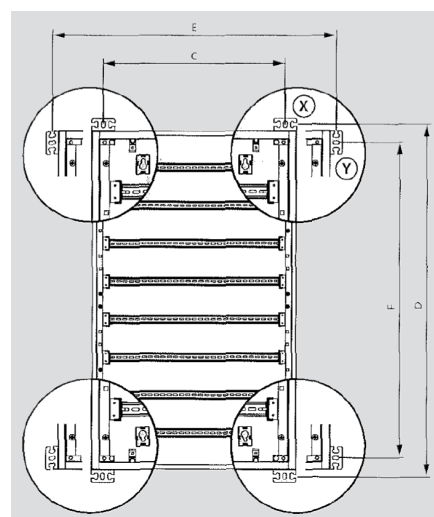

Cat. Nos		D (mm)	C (mm)	F (mm)	E (mm)
24 mod.	3 372 02	468		383	
	3 372 03	618		533	
	3 372 04	768		683	
	3 372 05	918	540	833	625
	3 372 06	1068		983	
	3 372 07	1218		1133	
	3 372 08	1368		1283	
36 mod.	3 372 14	768		683	
	3 372 15	918		833	
	3 372 16	1068	756	983	841
	3 372 17	1218		1133	
	3 372 18	1368		1283	

# SURFACE MOUNTING CABINETS

## Preparing the cabinets for use (continued)

### 3 COMBINATION/JOINING KIT (CAT. NO 3 374 07)

The cabinets can be combined vertically by using the kit Cat. No 3 374 04 composed of 4 screws and 4 nuts.

#### ■ Fitting

Join the cabinets together by using the 4 screws + nuts provided in the kit Cat. No 3 374 04. You might knock out the caps of the cabinets before joining.



#### ■ Preparing

Knock out or cut the top/bottom of the sides in order to insert the cables.

Knocked-out for cable gland.

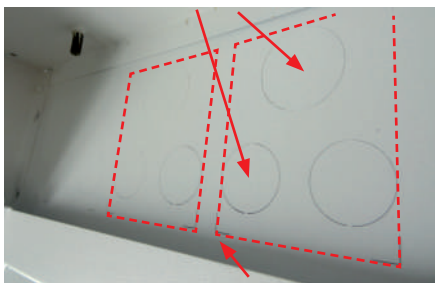

Rectangular area.



Internal view of the 1<sup>st</sup> cabinet

External view of the 2<sup>nd</sup> cabinet

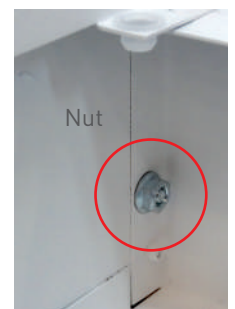
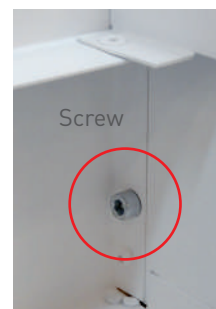

#### ■ Vertical assembly fixing centres

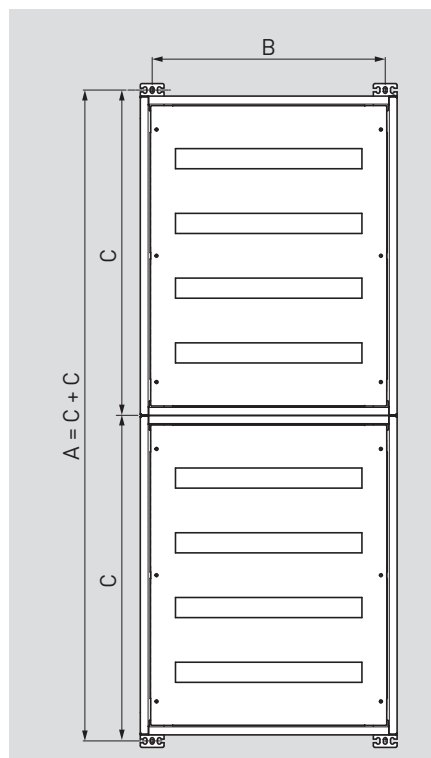

Cat. Nos		C (mm)	B (mm)
24 mod.	3 372 02	455	540
	3 372 03	605	
	3 372 04	755	
	3 372 05	905	
	3 372 06	1055	
	3 372 07	1205	
	3 372 08	1355	
36 mod.	3 372 14	755	756
	3 372 15	905	
	3 372 16	1055	
	3 372 17	1205	
	3 372 18	1355	



#### 4 FACEPLATES MOUNTING

The XL<sup>3</sup> S 160 are supplied with 1 or 2 faceplates (see the components in the opposite table). The faceplates are fixed on the cabinet with captive screws:

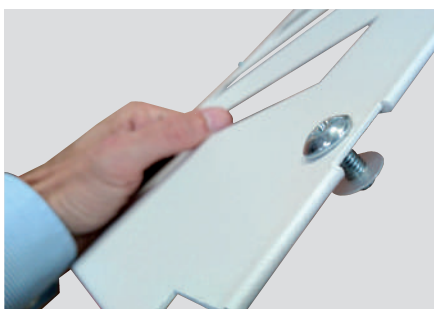

The plastic washer holds the screw on the faceplate and makes the handling easier.



The earth continuity between the faceplate and the cabinet is possible thanks to a claw (see picture below).



#### ■ Configuration by cabinet size

Cat. Nos		Number of faceplates		Number of fixing points
24 modules	3 372 02	1 faceplate of 2 rows		4
	3 372 03	1 faceplate of 3 rows		4
	3 372 04	1 faceplate of 4 rows		6
	3 372 05	1 faceplate of 5 rows		6
	3 372 06	2 faceplates of 3 rows		8
	3 372 07	1 faceplate of 4 rows + 1 faceplate of 3 rows		10
	3 372 08	2 faceplates of 4 rows		12
	36 modules	3 372 14	1 faceplate of 4 rows	
3 372 15		1 faceplate of 5 rows		6
3 372 16		2 faceplates of 3 rows		8
3 372 17		1 faceplate of 4 rows + 1 faceplate of 3 rows		10
3 372 18		2 faceplates of 4 rows		12

# SURFACE MOUNTING CABINETS

## Preparing the cabinets for use (continued)

### 4 FACEPLATES MOUNTING (CONTINUED)

#### ■ Fitting

For the installation of control and signalling units or devices with a voltage  $U > 50\text{ V}$  on the faceplate, it is necessary to add an equipotential link conductor between the faceplate and the cabinet.



To achieve this, you must bend the connecting lug of the faceplate with pliers.

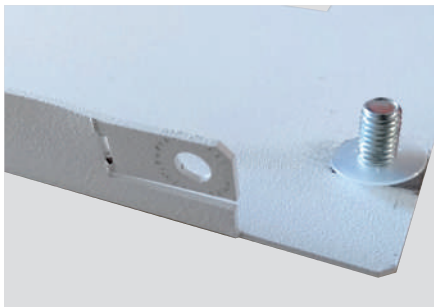

Connect the conductor (Cat. No 3 397 53) to the faceplate with a screw, a nut and 2 washers (not supplied) in order to ensure the continuity.

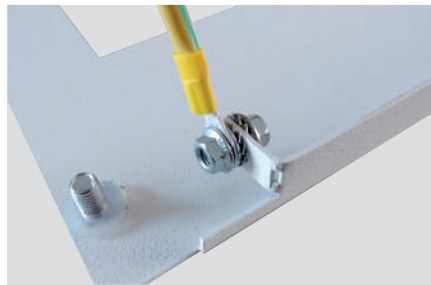

The connection on the cabinet is made by screwing a M6 nut (not supplied) on the specified attachment points.



### 5 SIGNALLING

As well as the label-holders on all DIN rail mounting equipment and the plastic marking strip Cat. No 0 203 99, a clip-on holder accessory is available for 24 modules (Cat. No 3 397 55) and 36 modules (Cat. No 3 397 56).



### 6 FITTING THE DOORS

The solid or glass doors can be fitted to open to the left or the right (see selection table page 3).

The slots for the hinges and the door release are provided on both sides of the cabinet.



Door kit components: 2 axis, 2 hinges, 1 handle up to 5 rows, 2 handles from 6 rows, 1 key and 1 cross bolt and 2 lip seals

#### ■ Finishes

To ensure the IP (Protection Index) of the cabinet you must:

1- Clip the blanking keyhole (supplied with the cabinet) on the side of the hinges.



2- Seal the holes at the opposite of the hinges (1 at the top and 1 at the bottom) by using the caps supplied with the cabinet.

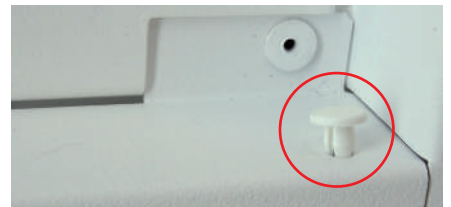

### ■ Fitting the hinges

1- Fit and clip the hinges in the specified slots on the door side.

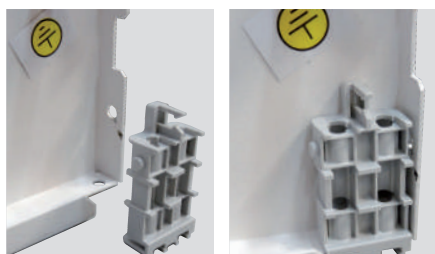

2- Insert the axis of the hinge in the specified hole.



3- Rotate the axis on 90° to lock the system.



The axis should be properly clipped in the specified location (see photo above).

### ■ Fitting the handle

1- Fit and insert the handle in the hole at the opposite of the hinges.

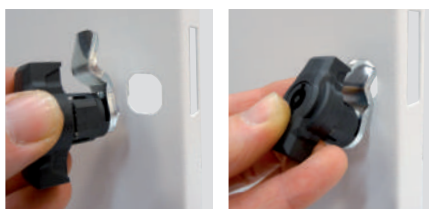

2- Insert the cross bolt at the back of the handle, against the door.



3- Once the door released of the handle installed, turn it with the key in lock position in order to check the proper functioning.



**i** Metal flat doors Cat. Nos 3 372 57, 3 372 58, 3 372 67, 3 372 68 and glass doors Cat. Nos 3 372 77, 3 372 78, 3 372 87, 3 372 88 are equipped with 2 handles.

**+** The door axis are designed to be and removed without tools. So the door installation is made easier.

### ■ Equipotential link

You have to make an equipotential link if control and signalling units or devices with voltage  $U > 50$  V are fitted on the door. The doors are equipped with studs for connecting the equipotential link conductor Cat. No 3 397 53.

1- Remove the dedicated plastic cover on the cabinet (2 covers available). Then, cut it to enable the cable to pass:

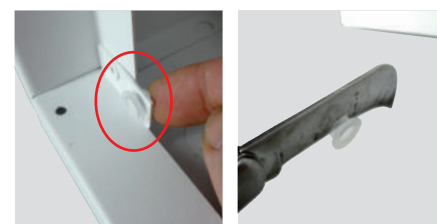

2- Put the plastic cover back in its location, fit the cable on the stud of the cabinet (with a M6 nut). Then, pass it through the cover:



3- Remove the protection cover of the earth stud on the door and fit the cable end with the help of a M6 nut.

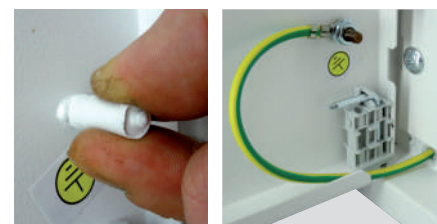

## Mounting devices

Cabinets are delivered with the rails of the chassis in the upper position, i.e. ready to install the modular products (MCB) as well as the Vistop < 160A.



The plug-in function of the chassis allows the rails to be adjusted and the products to be installed outside the cabinet, on a workbench or other. Wiring can thus be carried out in the workshop, at the same time as the cabinet is installed on site.

To remove the chassis from the cabinet, remove the 4 10 mm nuts (2 at the top and 2 at the bottom):



To replace the chassis, it must be inserted on the 2 lower studs and then on the 2 upper studs. Tighten the 4 nuts, starting with the 2 top ones:

### Lower part

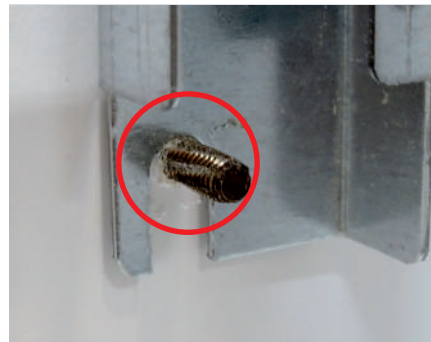

### 1 DRX 125 MOUNTING (AVAILABLE IN CERTAIN MARKETS)

To install these products, it is necessary to place the rail in an intermediate position and install the DRX using the corresponding adapters:

- Cat.no 0 271 87 for DRX 125 3P & 4P
- Cat.no 0 271 89 for DRX 125 1P
- Cat.no 0 271 90 for DRX 125 2P

Remove the rail by loosening the 2 screws with a Torx T30 end cap:

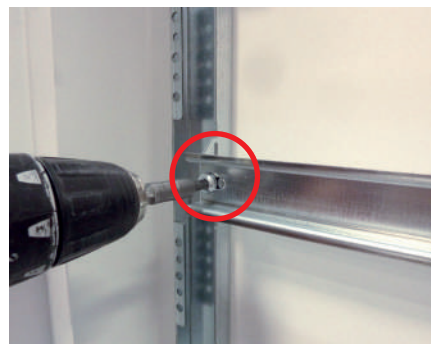

Twist both lugs 90° inwards:

### Before

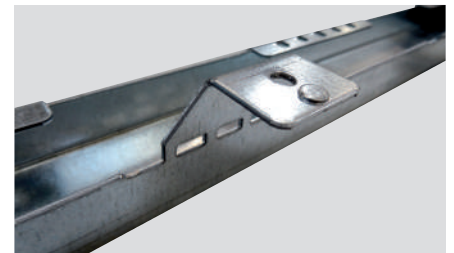

### After



Replace the rail with the 2 screws in the holes provided and then install the product.



Modular devices (MCB) can be mounted next to a DRX. To do this, use the rail extension Cat.no 3 382 41. After cutting it to length (if necessary), clip it onto the omega rail next to the DRX.

The depth is then correct to allow the faceplate to be fitted.

## 2 DPX<sup>3</sup> 160 MOUNTING

The rail must be placed in the low position and the DPX<sup>3</sup> must be equipped with the corresponding adapters:

- Cat.no 4 210 68 for DPX<sup>3</sup> 160 with side motor drive
- Cat.no 4 210 71 for DPX<sup>3</sup> 160 with no side motor drive
- Cat.no 4 210 73 for DPX<sup>3</sup> 160 with earth leakage modules with no side motor drive

Remove the rail by loosening the 2 screws with a Torx T30 end cap:

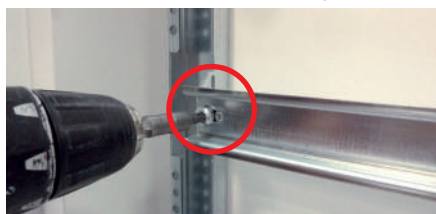

Twist both lugs (using pliers) outwards as far as possible so as to fold them into the uprights:

**Before**

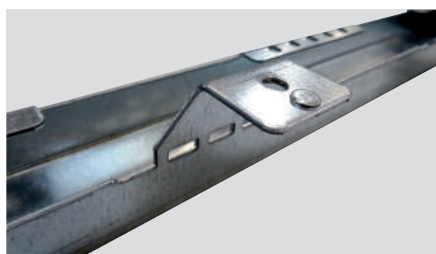

**After**



Install the height kit Cat.no 3 374 07 on both sides using the screws supplied (take the fixing holes circled in red below):

**Kit Cat.no 3 374 07**

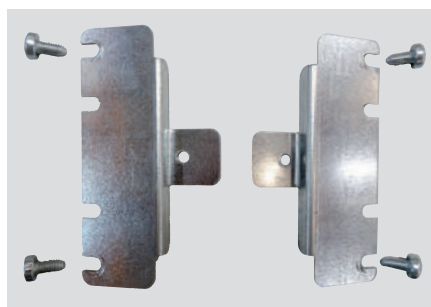

**Fixing holes**

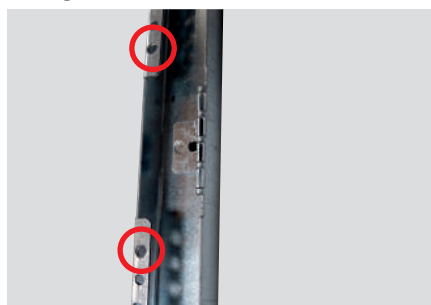

**Kit installed on a side**

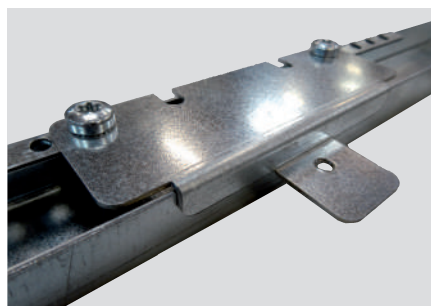



Replace the rail with the 2 screws in the holes provided and then install the product.

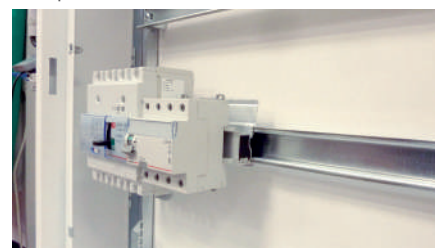

Modular devices (MCB) can be mounted next to a DPX<sup>3</sup> 160. For this purpose, the rail extension Cat.no 3 382 40 must be used. After cutting it to length (if required), it must be clipped onto the top hat rail next to the DPX<sup>3</sup>.

The depth is then correct to allow the faceplate to be fitted.



 It is also possible to combine a DRX 125 and a DPX<sup>3</sup> 160 in the same row by mounting the DRX (with its adapter) on the extension Cat.no 3 382 42.

The rail must be in the low position (see paragraph 2).

The mounting of the DPX<sup>3</sup> 160 is detailed in section 2.

## Wiring and connection

### 1 INSERTING OF THE CABLES/ CABLES ENTRY

The XL<sup>3</sup> S 160 are fitted with knockout cable entries in order to mount cable glands ISO 25 and/or ISO 32:

- 24 modules: 14 entries Ø 25 and 7 entries Ø 32
- 36 modules: 20 entries Ø 25 and 10 entries Ø 32

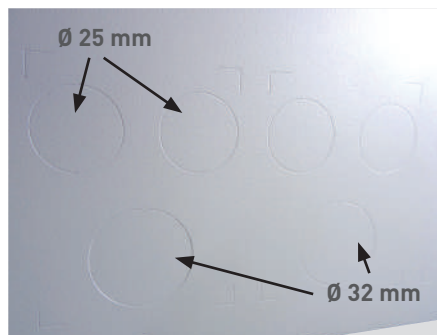

It's also possible to cut rectangular areas to allow the circulation of several cables.

The angles are pre-marked on the top and at the bottom of the cabinet. The cutting is done using a jigsaw or a tube cutter.

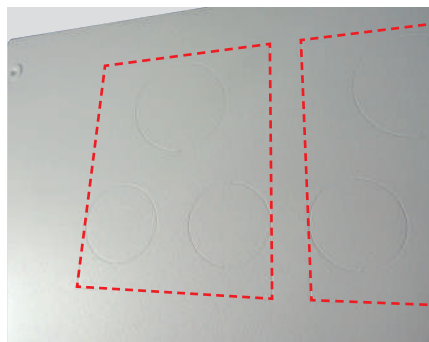

Number of modules	Rectangular knockout entries Number and dimension
24	7 (62x80) mm
36	10 (62x80) mm

## 2 PROTECTIVE CONDUCTORS AND IP 2X DISTRIBUTION TERMINAL BLOCKS

First, you need to fit the mounting lugs which are supplied with the cabinet (2 lugs) by using the nuts.

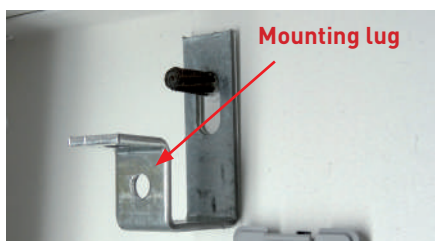

The brass terminal block Cat. No 0 373 00 can be fixed on the lugs supplied with the cabinet (with the 2 screws and 2 nuts supplied with the Cat. No 0 373 00).

4 positions in the cabinets are possible. → 2 at the top and/or 2 at the bottom.

Here is example with 2 earth terminal blocks at the top of the cabinet.



To make the wiring of the protective conductors, it's also possible to use one (or more) copper bars Cat. No 0 373 89 that you have to cut. (Original length → 990 mm).

As the holes of the bar are threaded, the mounting lugs are placed between the copper bar and the screw heads (M5 screws, not supplied)

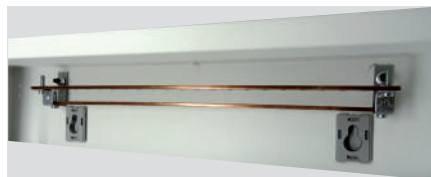

### Maximum length:

**24 modules** → maximum length 510 mm

**36 modules** → maximum length 726 mm  
Fixing centres: 400 mm in 24 modules cabinets and 616 mm in 36 modules cabinets.

Drilling: Ø 5 mm. Fixing screw: M5 + nuts (not supplied).

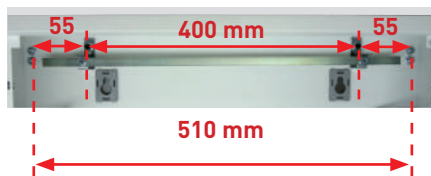

Example with 24 modules cabinet

### Minimum length:

**24 modules** → minimum length 410 mm

**36 modules** → minimum length 630 mm  
Fixing centres: 400 mm in 24 modules cabinets and 616 mm in 36 modules cabinets.

Drilling: Ø 5 mm. Fixing screw: M5 + nuts (not supplied).

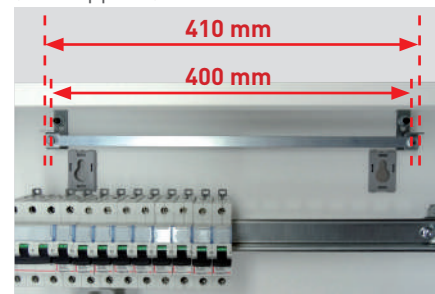

Example with 24 modules cabinet

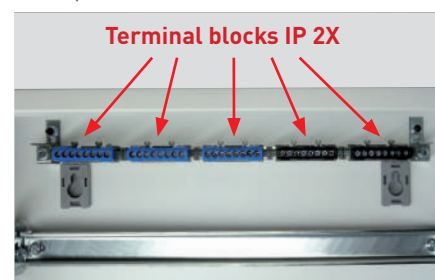

 2 additional 47 mm (maximum) terminal blocks (IP 2X or bare) Cat. Nos 0 048 20, 0 048 30, 0 048 40 or 0 048 50 can be fixed on each side of the 12 x 2 mm flat bar, when cut to the maximum length.



## Accessories mounting

### BLANKING PLATES

5 MODULES (CAT. NO 0 016 60)

24 MODULES (CAT. NO 3 397 54)

36 MODULES (CAT. NO 3 397 55)

The blanking plates allow covering the modular frames of the XL<sup>3</sup> S 160 faceplates.

You can use the 5 modules blanking plates Cat. No 0 016 60 (white colour RAL9003) and divisible in a module or half-module.

It's also possible to use the 24 modules Cat. No 3 397 54, and 36 modules Cat. No 3 397 55 blanking plate.

#### ■ Example of a blanking plate mounting Cat. No 0 016 60:

First, insert the lower part of the blanking plate in the modular frame.

Clip the upper part by pushing in direction of the faceplate.

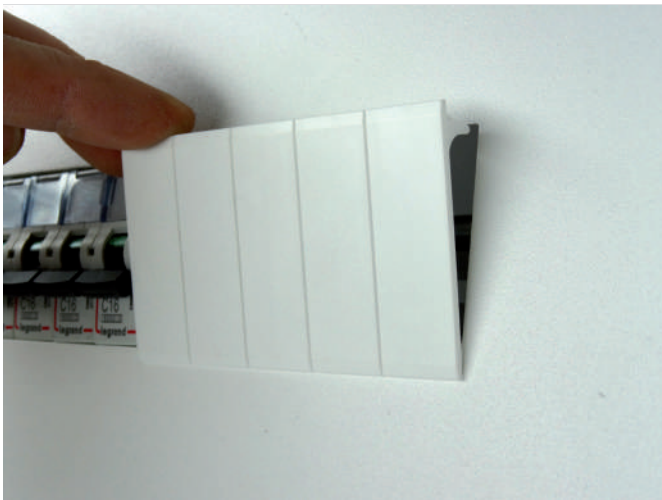



## DOCUMENTS HOLDER

**OPEN: WIDTH 340 X 235 (CAT. NO 0 365 80)**

**OPEN: WIDTH 260 X 165 (CAT. NO 0 365 81)**

**CLOSED: IP50 WIDTH 324 X 120 (CAT. NO 0 365 82)**

**FLEXIBLE: WIDTH 305 X 220 (CAT. NO 0 097 99)**

The adhesive document holders allow storing the electrical plan, instruction manual, technical sheets... in the cabinet. They are often fixed on the lower part of the door.

### ■ Example of a document holder mounting

Remove the plastic film of the double-sided adhesive type positioned at the back of the holder. Then, stick it wherever you want.

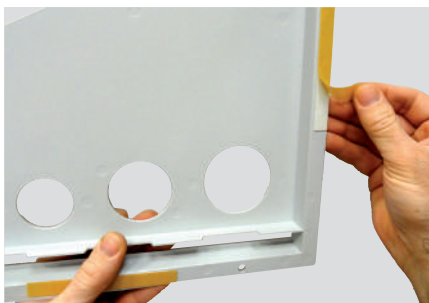

Cat. Nos 0 365 80, 0 365 81 :



Cat. No 0 365 82 :

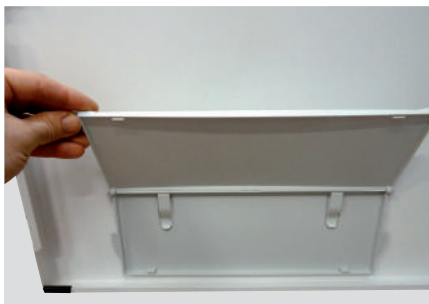

Cat. No 0 097 99 :



# FLUSH-MOUNTING CABINETS

The XL<sup>3</sup> S 160 flush-mounting cabinets have optimised dimensions for distribution up to 160 A.

They have been designed in order to simplify the protection equipment installation and the wiring operations.

- DIN rail
- Removable chassis,
- Removable finishing frame,
- Adjustable flush-mounting box for cable insertion.

XL<sup>3</sup> S 160 also offers original solutions for holding and running the wiring, a large working area.

## SPECIFICATIONS

- Class I metal cabinet
- Rated peak withstand current I<sub>pk</sub>: 34kA
- IP 30 without door, IP 40 with door
- IK 07 without door, IK 08 with door
- Door opening angle: 130°
- Conforming to standard IEC 61439-2
- Can take devices up to 160 A
- Colour RAL 9003
- Maximum rated voltage (U<sub>e</sub>) up to 500V ~
- Rated insulation voltage: (U<sub>i</sub>) 1000V ~
- Rated impulse withstand voltage (U<sub>imp</sub>):
  - 8 kV (moulded case)
  - 4 kV (modular)
- Supplied complete with rails, multi-rows faceplates, knock-out cable entry and support for terminal blocks (neutral and earth)

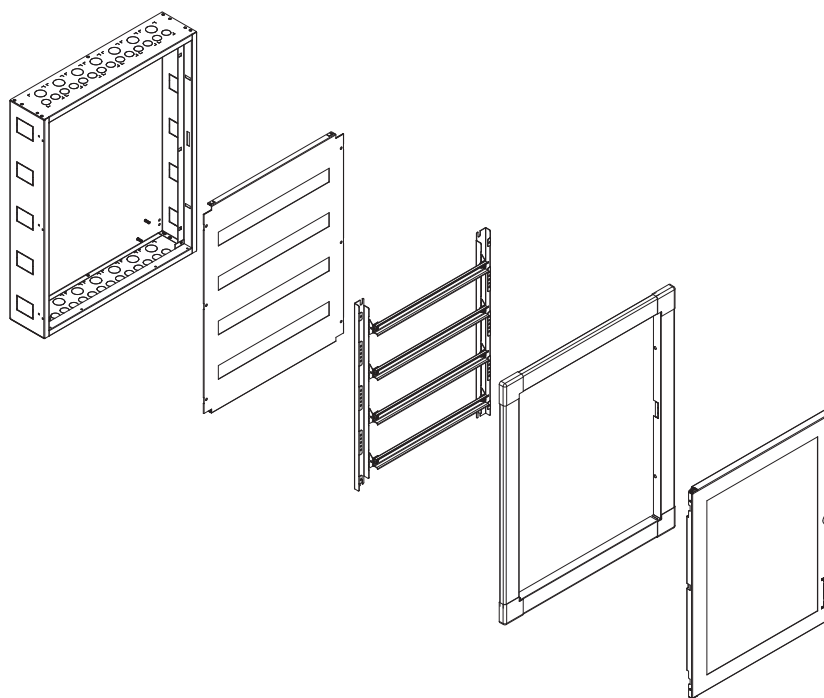

## PRODUCTS SELECTION



The XL<sup>3</sup> S 160 range contains “fully modular” cabinets, from 2 to 8 rows of 24 modules and from 4 to 8 rows of 36 modules.

**i** Possibilité de choisir une couleur spéciale parmi un panel de 197 nuances : RAL uniquement possible sur les parties métalliques.  
Pour toute demande sur les possibilités techniques et surcoût, merci de contacter le support technique : [support-technique-edia.fr-lgs@legrand.fr](mailto:support-technique-edia.fr-lgs@legrand.fr)

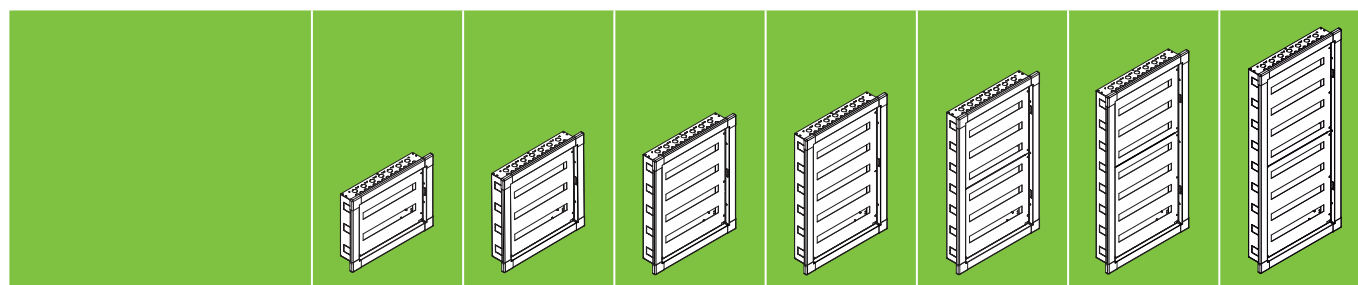
### THE XL<sup>3</sup> S 160 FLUSH-MOUNTING CABINET RANGE



#### 24 MODULES PER ROW

<b>Cat. Nos</b>	3 372 22	3 372 23	3 372 24	3 372 25	3 372 26	3 372 27	3 372 28
<b>Number of rows</b>	2	3	4	5	6	7	8
<b>Number of modules</b>	48	72	96	120	144	168	192
<b>Metal door (flat)</b> 	3 372 52	3 372 53	3 372 54	3 372 55	3 372 56	3 372 57	3 372 58
<b>Glass door (flat)</b> 	3 372 72	3 372 73	3 372 74	3 372 75	3 372 76	3 372 77	3 372 78

#### 36 MODULES PER ROW

<b>Cat. Nos</b>	-	-	3 372 34	3 372 35	3 372 36	3 372 37	3 372 38
<b>Number of rows</b>	-	-	4	5	6	7	8
<b>Number of modules</b>	-	-	144	180	216	252	288
<b>Metal door (flat)</b> 	-	-	3 372 64	3 372 65	3 372 66	3 372 67	3 372 68
<b>Glass door (flat)</b> 	-	-	3 372 84	3 372 85	3 372 86	3 372 87	3 372 88

## Preparing the cabinets for use

The XL<sup>3</sup> S 160 cabinets are supplied in a cardboard packaging reusable for delivery to the site.



The cabinet is supplied with 3 packs. The 1<sup>st</sup> one contains 2 screws to fix the terminal block supports, 2 terminal block supports, 4 blanking plates for keyhole, 8 covers (plugs) for joining/combination, 4 caps for the hinge holes.



The 2<sup>nd</sup> pack contains: 4 masonry anchors, 8 fixing screws and 8 nuts:



The 3<sup>rd</sup> pack contains: 4 clip-nuts, 4 screws (for clip-nuts) and 8 screws for corners fixing:



The frame and the corners are supplied with the cabinet:

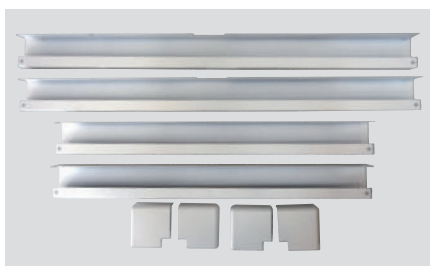

### 1 DIMENSIONS

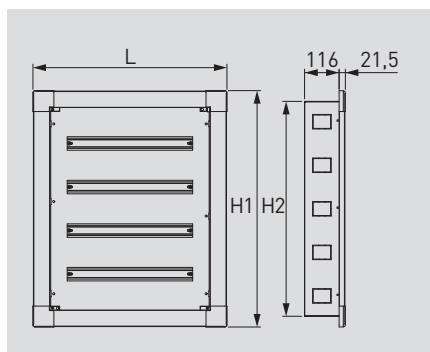

Cat. Nos		H1 (mm)	H2 (mm)	W (mm)
24 mod.	3 372 22	512	440	667
	3 372 23	662	590	
	3 372 24	812	740	
	3 372 25	962	890	
	3 372 26	1112	1040	
	3 372 27	1262	1190	
	3 372 28	1412	1340	
36 mod.	3 372 34	812	740	883
	3 372 35	962	890	
	3 372 36	1112	1040	
	3 372 37	1262	1190	
	3 372 88	1412	1340	

## 2 FLUSH-MOUNTING

It's only possible by fixing the cabinet in a masonry wall (cinder block, engineering/ plain brick and aerated concrete) or a partition in hard materials (partition brick, precast plaster blocks and aerated concrete) associated to isolation in many cases.

Cabinets can be fixed using plaster, adhesive mortar or cement, as required.

### ■ Flush-mounting dimensions of the 24 and 36 modules cabinets

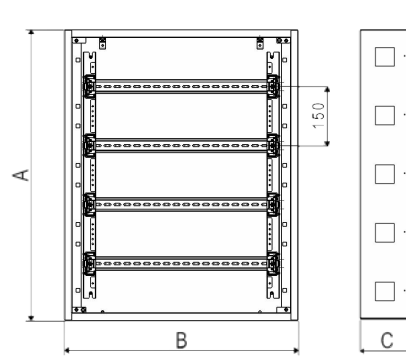

Cat. Nos	A	B	C	
24 modules	3 372 22	595	440	135
	3 372 23	590	595	
	3 372 24	740	595	
	3 372 25	811	740	
	3 372 26	890	595	
	3 372 27	890	811	
	3 372 28	1040	595	
36 modules	3 372 34	1040	811	135
	3 372 35	1190	595	
	3 372 36	1190	811	
	3 372 37	1340	595	
	3 372 38	1340	811	

The flush-mounting width must be expanded at the masonry anchors (+ 35mm in width per anchor).

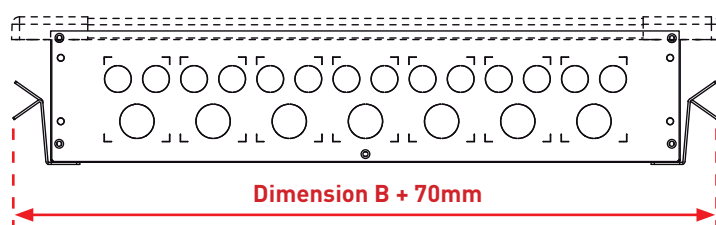

The hole in the masonry wall must have a minimum depth of 135 mm.

The set partition + isolation must have a minimum depth of 135 mm, including a minimum depth of 100 mm for the partition. (The anchors sealing is made at mid-depth of the cabinet, i.e. approximately 70 mm).

# FLUSH-MOUNTING CABINETS

## Preparing the cabinets for use (continued)

### 2 FLUSH-MOUNTING (CONTINUED)

#### ■ Cut of the cable entries

Knockout and cut the upper or bottom side panel of the cabinets in order to run the sleeves.



#### ■ Masonry anchors mounting

Fit the masonry anchors which are supplied with the cabinet (x 4) by using the screws (x 8) and the M6 nuts (x 8) supplied.

#### Screws at the back of the cabinet:

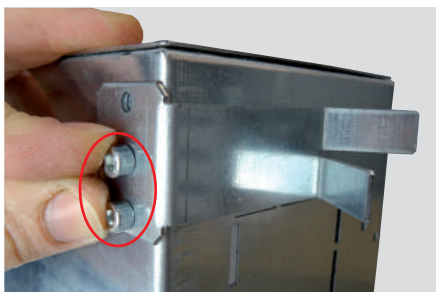

#### Nuts inside the cabinet:

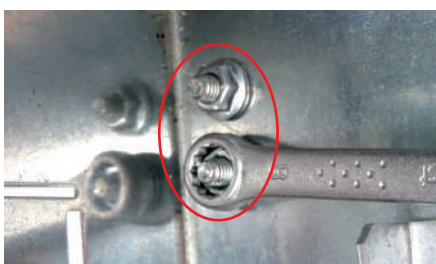

#### ■ Installation in the wall

Position the cabinet at level against the wall and draw the outlines. The position of the 4 fixing lugs can be made in the same time:



Cut of the wall or the partition:

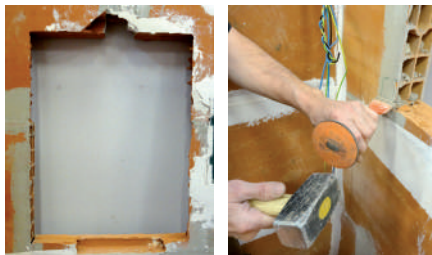

Fit the cabinet in the hole and insert all sheaths.



Seal the lugs then, furnish around the cabinet with some plaster, adhesive mortar or concrete:



On the side panel of the cabinet, 2 marks indicate the maximum and the minimum depth for the flush-mounting (including the finishing).

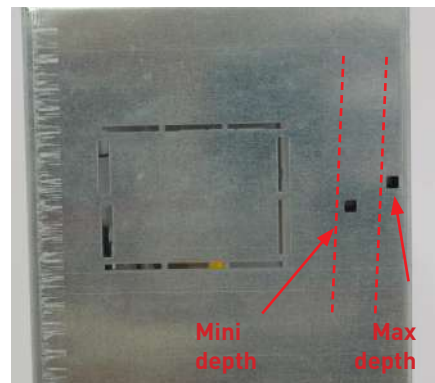

#### Minimum depth:



#### Maximum depth:



### 3 FRAME MOUNTING AND INSTALLATION

#### ■ Frame mounting

Gather the 4 parts of the frame with the corners and fix them together by using the 8 screws supplied (2 per angle).

**Example for one corner:**

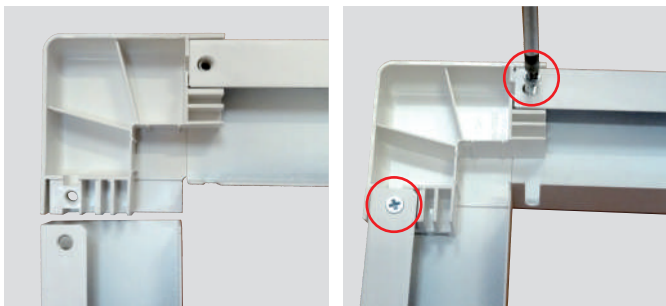

Picture of the assembled frame (interior side):

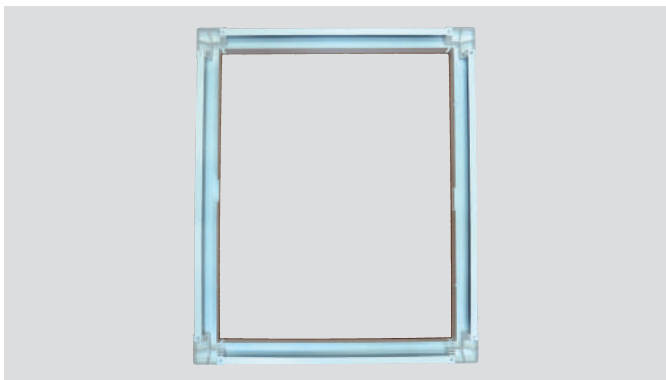

#### Frame fitting

1- Fit the clip-nuts supplied on the sides of the cabinets in order to fix and adjust the frame:

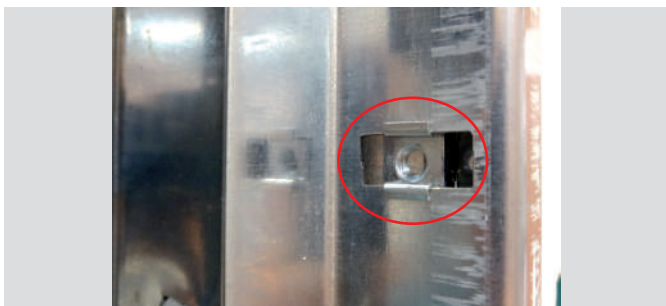

2- Depending on the flush-mounting depth of the cabinet, it will be necessary to remove the pre-cut on the frame to allow the handle latch to be inserted.

Minimum depth → yes

Maximum depth → no

Put the frame (in the stop/abutment) on the wall to define the correct option.

Part to remove in case of need.

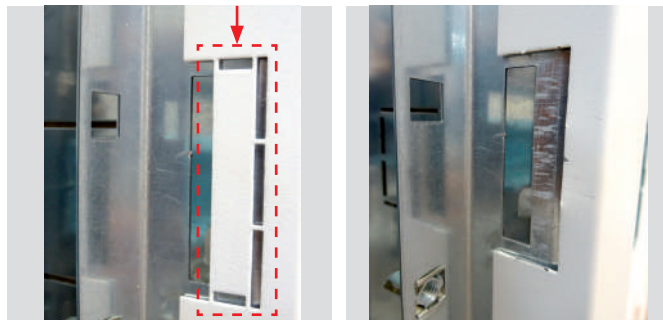

3- Put the frame on the wall and screw it in the clip-nuts with the screws supplied:



4- Still depending on the flush-mounting depth, it will be necessary to clip one or many plastic covers (depending on the number of handles on the door) supplied at the opposite of one (or many) keyhole → side of the hinges

Minimum depth → no

Maximum depth → yes

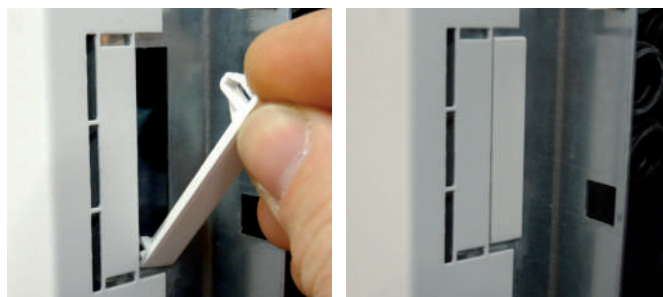

# FLUSH-MOUNTING CABINETS

## Preparing the cabinets for use (continued)

### 4 FACEPLATES MOUNTING

#### ■ Fitting

The XL<sup>3</sup> S 160 are supplied with 1 or 2 faceplates (see the components in the adjacent table). The faceplates are fixed on the cabinet with captive screws:

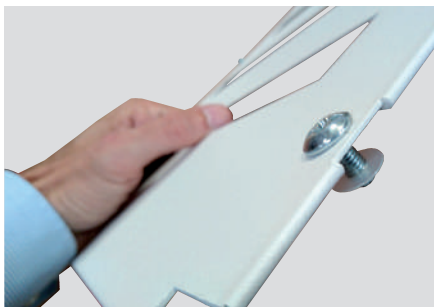

The plastic washer holds the screw on the faceplate and makes the handling easier.



The earth continuity between the faceplate and the cabinet is possible thanks to a claw (see picture below).



#### ■ Configuration by cabinet size

Cat. Nos		Number of faceplates		Number of fixing points
24 modules	3 372 22	1 faceplate of 2 rows		4
	3 372 23	1 faceplate of 3 rows		4
	3 372 24	1 faceplate of 4 rows		6
	3 372 25	1 faceplate of 5 rows		6
	3 372 26	2 faceplates of 3 rows		8
	3 372 27	1 faceplate of 4 rows + 1 faceplate of 3 rows		10
	3 372 28	2 faceplates of 4 rows		12
36 modules	3 372 34	1 faceplate of 4 rows		6
	3 372 35	1 faceplate of 5 rows		6
	3 372 36	2 faceplates of 3 rows		8
	3 372 37	1 faceplate of 4 rows + 1 faceplate of 3 rows		10
	3 372 38	2 faceplates of 4 rows		12



#### 4 FACEPLATES MOUNTING (CONTINUED)

For the installation of control and signalling units or devices with a voltage  $U > 50$  V on the faceplate, it is necessary to add an equipotential link conductor between the faceplate and the cabinet.

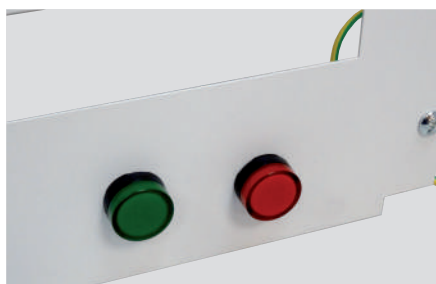

To achieve this, you must bend the connecting lug of the faceplate with pliers.

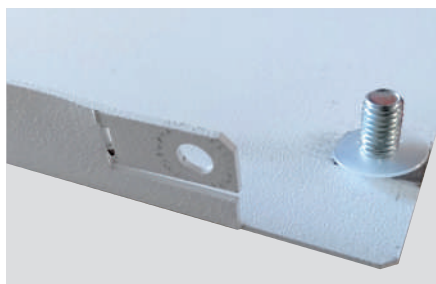

Connect the conductor (Cat. No 3 397 53) to the faceplate with a screw, a nut and 2 washers (not supplied) in order to ensure the continuity.



The connection on the cabinet is made by screwing a M6 nut (not supplied) on the specified attachment points.



#### 5 SIGNALLING

As well as the label-holders on all DIN rail mounting equipment and the plastic marking strip Cat. No 0 203 99, a clip-on holder accessory is available for 24 modules (Cat. No 3 397 55) and 36 modules (Cat. No 3 397 56).

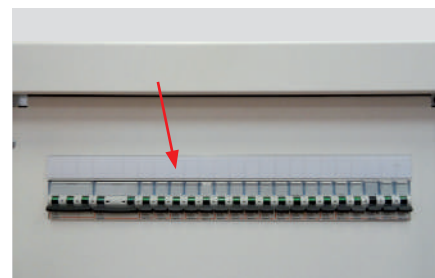

# FLUSH-MOUNTING CABINETS

## Preparing the cabinets for use (continued)

### 6 FITTING THE DOORS

The solid or glass doors can be fitted to open to the left or the right (see selection table page 3).

The slots for the hinges and the door release are provided on both sides of the cabinet.



Door kit components: 2 axis, 2 hinges, 1 handle up to 5 rows or 2 handles from 5 rows, 1 key and 1 cross bolt and 2 lip seals.

#### ■ Finishes

To ensure the IP (Protection Index) of the cabinet you must plug the holes in the opposite of the hinges (1 at the top and 1 at the bottom) by using the cap supplied with the cabinet.



#### ■ Fitting the hinges

1- Fit and clip the hinges in the specified slots on the door side.

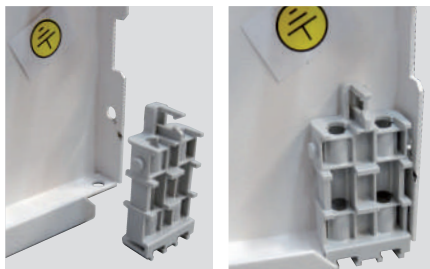

2- Insert the axis of the hinge in the specified hole.



3- Rotate the axis on 90° to lock the system.



The axis should be properly clipped in the specified location (see photo above).

### ■ Fitting the handle

1- Fit and introduce the handle in the hole.

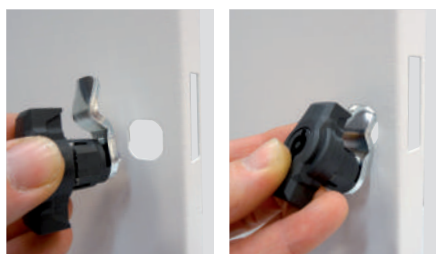

2- Insert the cross bolt at the back of the handle, against the door.



3- Once the door release of the handle installed, turn it with the key in lock position in order to check the proper functioning.



**i** Metal doors Cat. Nos 3 372 57, 3 372 58, 3 372 67, 3 372 68 and glass doors Cat. Nos 3 372 77, 3 372 78, 3 372 87, 3 372 88 are equipped with 2 handles.

**+** The door axis are designed to be fit and removed without tools. The door installation is made easier.

### ■ Equipotential link

You have to make an equipotential link if control and signalling units or device with voltage  $U > 50$  V are fitted on the door. The doors are equipped with studs for connecting the equipotential link conductor Cat. No 3 397 53.

1- Remove the dedicated plastic cover on the cabinet (2 covers available). Then, cut it to enable the cable to pass:

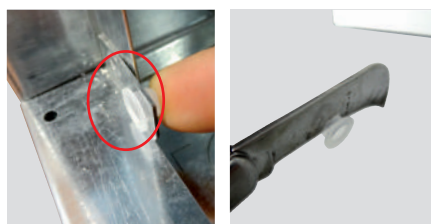

2- Put the plastic cover back in its location, fit the cable on the stud of the cabinet (with a M6 nut). Then, pass it through the cover:



3- Remove the protection cover of the earth stud and fit the cable and with the help of a M6 nut.



# FLUSH-MOUNTING CABINETS

## Preparing the cabinets for use (continued)

### Mounting devices

Cabinets are delivered with the rails of the chassis in the upper position, i.e. ready to install the modular products (MCB) as well as the Vistop < 160A.



The plug-in function of the chassis allows the rails to be adjusted and the products to be installed outside the cabinet, on a workbench or other. Wiring can thus be carried out in the workshop, at the same time as the cabinet is installed on site.

To remove the chassis from the cabinet, remove the 4 10 mm nuts (2 at the top and 2 at the bottom):

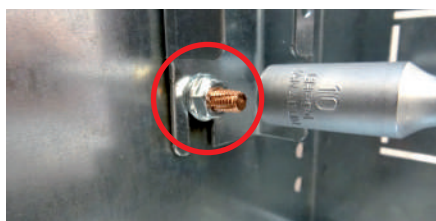

To replace the chassis, it must be inserted on the 2 lower studs and then on the 2 upper studs. Tighten the 4 nuts, starting with the 2 top ones:

#### Lower part

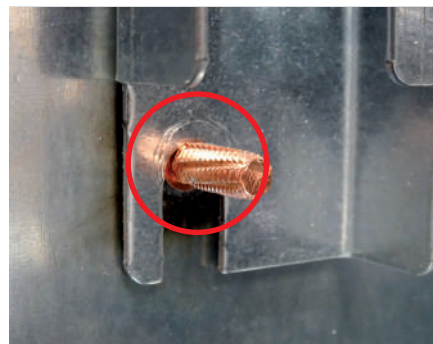

#### 1 DRX 125 MOUNTING (AVAILABLE IN CERTAIN MARKETS)

To install these products, it is necessary to place the rail in an intermediate position and install the DRX using the corresponding adapters:

- Cat.no 0 271 87 for DRX 125 3P & 4P
- Cat.no 0 271 89 for DRX 125 1P
- Cat.no 0 271 90 for DRX 125 2P

Remove the rail by loosening the 2 screws with a Torx T30 end cap:

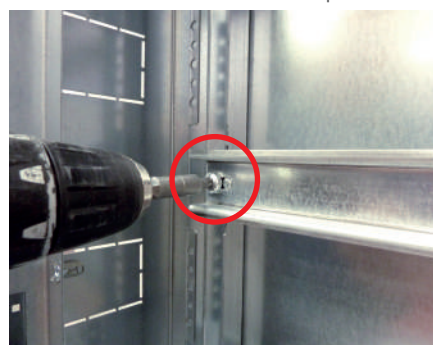

Twist both lugs 90° inwards:

#### Before

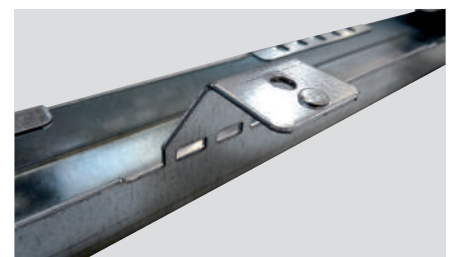

#### After



Replace the rail with the 2 screws in the holes provided and then install the product.



Modular devices (MCB) can be mounted next to a DRX. To do this, use the rail extension Cat.no 3 382 41. After cutting it to length (if necessary), clip it onto the omega rail next to the DRX.

The depth is then correct to allow the faceplate to be fitted.

## 2 DPX<sup>3</sup> 160 MOUNTING

The rail must be placed in the low position and the DPX<sup>3</sup> must be equipped with the corresponding adapters:

- Cat.no 4 210 68 for DPX<sup>3</sup> 160 with side motor drive
- Cat.no 4 210 71 for DPX<sup>3</sup> 160 with no side motor drive
- Cat.no 4 210 73 for DPX<sup>3</sup> 160 with earth leakage modules with no side motor drive

Remove the rail by loosening the 2 screws with a Torx T30 end cap:



Twist both lugs (using pliers) outwards as far as possible so as to fold them into the uprights:

**Before**

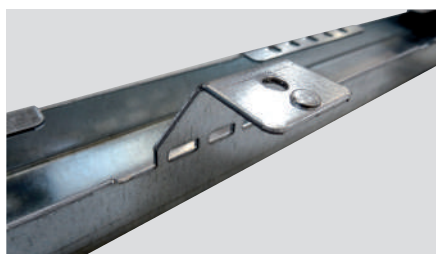

**After**



Install the height kit Cat.no 3 374 07 on both sides using the screws supplied (take the fixing holes circled in red below):

**Kit Cat.no 3 374 07**

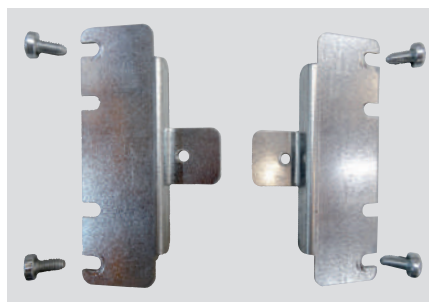

**Fixing holes**

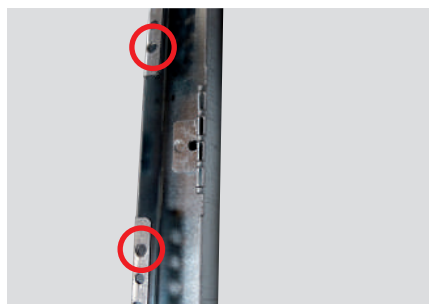

**Kit installed on a side**

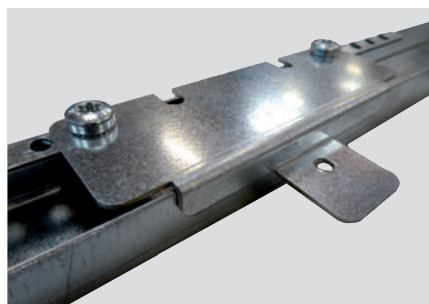



Replace the rail with the 2 screws in the holes provided and then install the product.

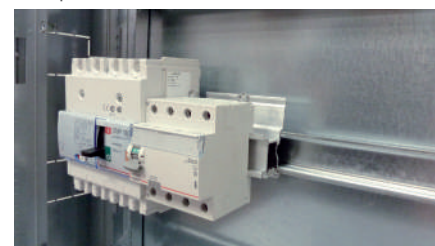

Modular devices (MCB) can be mounted next to a DPX<sup>3</sup> 160. For this purpose, the rail extension Cat.no 3 382 40 must be used. After cutting it to length (if required), it must be clipped onto the top hat rail next to the DPX<sup>3</sup>.

The depth is then correct to allow the faceplate to be fitted.



 It is also possible to combine a DRX 125 and a DPX<sup>3</sup> 160 in the same row by mounting the DRX (with its adapter) on the extension Cat.no 3 382 42.

The rail must be in the low position (see paragraph 2).

The mounting of the DPX<sup>3</sup> 160 is detailed in section 2.

## Wiring and connection

### 1 INSERTING OF THE CABLES/ CABLES ENTRY

The XL<sup>3</sup> S 160 are fitted with knockout cable entries in order to mount cable glands ISO 25 and/or ISO 32:

#### ■ Number of cylindrical entries

- 24 modules: 14 entries Ø 25 and 7 entries Ø 32
- 36 modules: 20 entries Ø 25 and 10 entries Ø 32

#### ■ Number of rectangular entries

Number of modules	Rectangular knockout entries Number and dimension
24	7 (62x80) mm
36	10 (62x80) mm

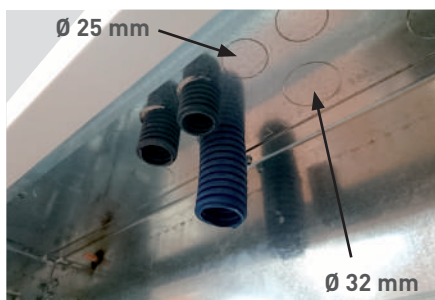

It's also possible to cut rectangular areas to allow the circulation of several sleeves.

The angles are pre-marked on the top and at the bottom of the cabinet. The cutting is done using a jigsaw or a tube cutter.

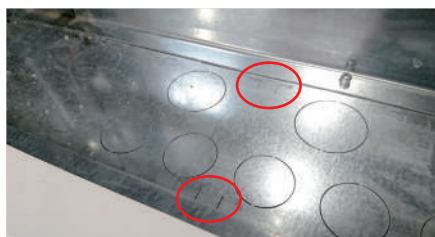

## PROTECTIVE CONDUCTORS AND IP 2X DISTRIBUTION TERMINAL BLOCKS

First, you need to fit the mounting lugs which are supplied with the cabinet (2 lugs) by using the nuts.

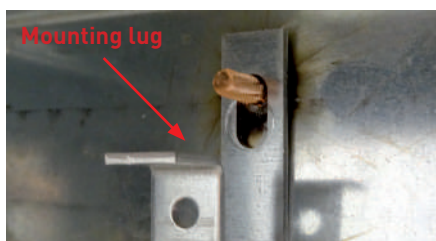

Mounting lug

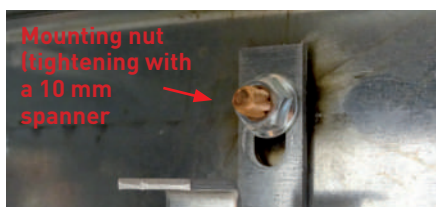

Mounting nut (tightening with a 10 mm spanner)

The brass terminal block Cat. No 0 373 00 that is fixed on the lugs supplied with the cabinet (with the 2 screws and 2 nuts supplied with the Cat. No 0 373 00). 4 positions in the cabinets are possible. → 2 at the top and/or 2 at the bottom.

Here is example with 2 earth terminal blocks at the top of the cabinet.



To make the wiring of the protective conductors, it's also possible to use one (or more) copper bars Cat. No 0 373 89 that you have to cut. (Original length → 990 mm).

As the holes of the bar are threaded, the mounting lugs are placed between the copper bar and the screw heads (M5 screws, not supplied)



For the installation of an IP 2X distribution terminal block, you need to use a flat bar 12 x 2 mm Cat. No 0 048 19. This bar is also fixed on the lugs supplied with the cabinet. You must cut and drill it, as follows:

### Maximum length:

**24 modules** → maximum length 510 mm

**36 modules** → maximum length 726 mm

Fixing centres: 400 mm in 24 modules cabinets and 616 mm in 36 modules cabinets.

Drilling: Ø 5 mm. Fixing screw: M5 + nuts (not supplied).

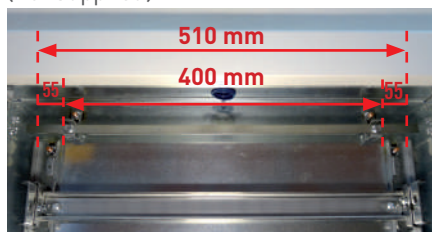

Exemple with 24 modules cabinet

### Minimum length:

**24 modules** → minimum length 410 mm

**36 modules** → minimum length 630 mm

Fixing centres: 400 mm in 24 modules cabinets and 616 mm in 36 modules cabinets

Drilling: Ø 5 mm. Fixing screw: M5 + nuts (not supplied).

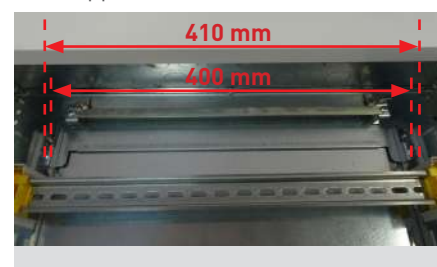

Exemple with 24 modules cabinet

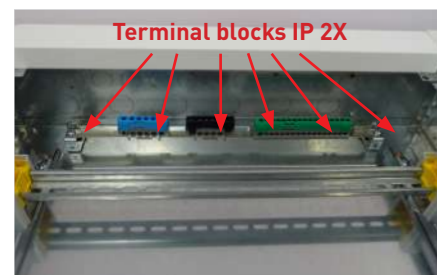

Terminal blocks IP 2X

2 additional 47 mm (max.) terminal blocks (IP 2X or bare) Cat. Nos 0 048 20, 0 048 30, 0 048 40 or 0 048 50 can be fixed on each side of the 12 x 2 mm flat bar, when cut to the maximum length.

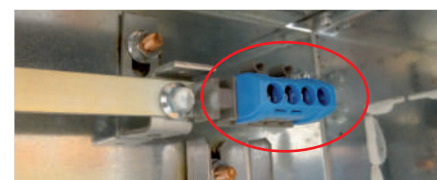

## Accessories mounting

### BLANKING PLATES

5 MODULES (CAT. NO 0 016 60)

24 MODULES (CAT. NO 3 397 54)

36 MODULES (CAT. NO 3 397 55)

The blanking plates allow covering the modular frames of the XL<sup>3</sup> S 160 faceplates.

You can use the 5 modules blanking plates Cat. No 0 016 60 (white colour RAL9003) and divisible in a module or half-module.

It's also possible to use the 24 modules Cat. No 3 397 54, and 36 modules Cat. No 3 397 55 blanking plate.

#### ■ Example of a blanking plate mounting Cat. No 0 016 60:

First, insert the lower part of the blanking plate in the modular frame.

Clip the upper part by pushing in direction of the faceplate.

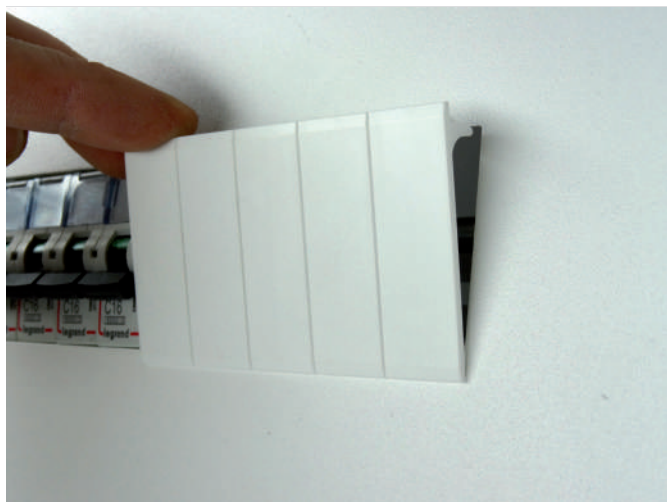



## DOCUMENTS HOLDER

**OPEN: WIDTH 340 X 235 (CAT. NO 0 365 80)**

**OPEN: WIDTH 260 X 165 (CAT. NO 0 365 81)**

**CLOSED: IP50 WIDTH 324 X 120 (CAT. NO 0 365 82)**

**FLEXIBLE: WIDTH 305 X 220 (CAT. NO 0 097 99)**

The adhesive document holders allow storing the electrical plan, instruction manual, technical sheets... in the cabinet. They are often fixed on the lower part of the door.

### ■ Example of a document holder mounting

Remove the plastic film of the double-sided adhesive type positioned at the back of the holder. Then, stick it wherever you want.

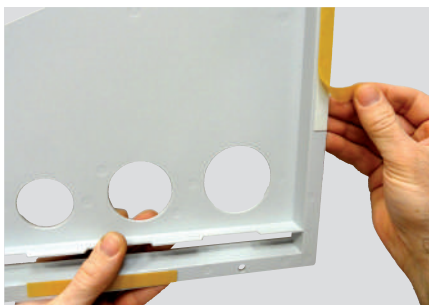

Cat. Nos 0 365 80, 0 365 81 :



Cat. No 0 365 82 :

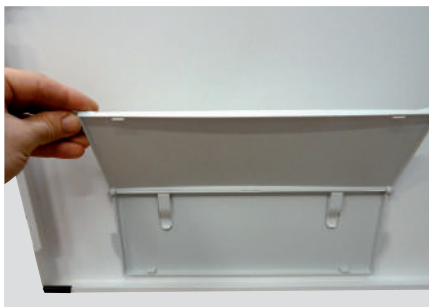









Cat. No 0 097 99 :



# ACCESSORIES AND SPARE PARTS

CAT. NOS	DESIGNATION	CONTENTS	
3 374 00	Wall mounting lugs (supplied by 4)		4 lugs, 8 screws, 8 nuts
0 048 19	12x2 flat bar 1 m length		x 1
0 373 00	Additional brass bar		1 bar 2 screws, 2 nuts
3 374 04	Kit for joining		4 screws, 4 nuts
0 365 80	Open adhesive document holder - width 340x height 165 grey RAL 7035		x 1
0 365 81	Open adhesive document holder - width 260x height 165 grey RAL 7035		x 1
0 365 82	Closed adhesive document holder - IP50 - 324x120x18 grey RAL 7035		x 1
0 097 99	Plastic flexible document holder - 305x220 mm - transparent		x 1
3 382 40	Rail DPX <sup>3</sup> + modular adaptor		x 1
3 374 07	Height kit for DPX <sup>3</sup> 160		2 lugs 4 self-tapping screws

CAT. NOS	DESIGNATION	CONTENTS	
0 016 60	White 5 modules blanking plate RAL 9010		1 blanking plate 5 modules
3 397 10	Handle		1 handle 1 cross bolt
3 397 53	Equipotential link conductor		x 1
3 397 55	24 modules Clip-on adhesive holder		1 holder 1 labels sheet
3 397 57	36 modules Brass bar		x 1
3 397 54	24 modules blanking plate		x 1
3 397 56	36 modules Clip-on adhesive holder		1 holder 1 labels sheet
9 809 01	Door hinge		1 hinge 1 axis
9 809 03	2 terminal block supports kit		2 supports 2 nuts



To know more,  
check [export.legrand.com](http://export.legrand.com)



All technical data of the products inside this workshop specifications book are available on: [www.export.legrand.com/en](http://www.export.legrand.com/en)

Click on **>DOCUMENTATION & SOFTWARE**

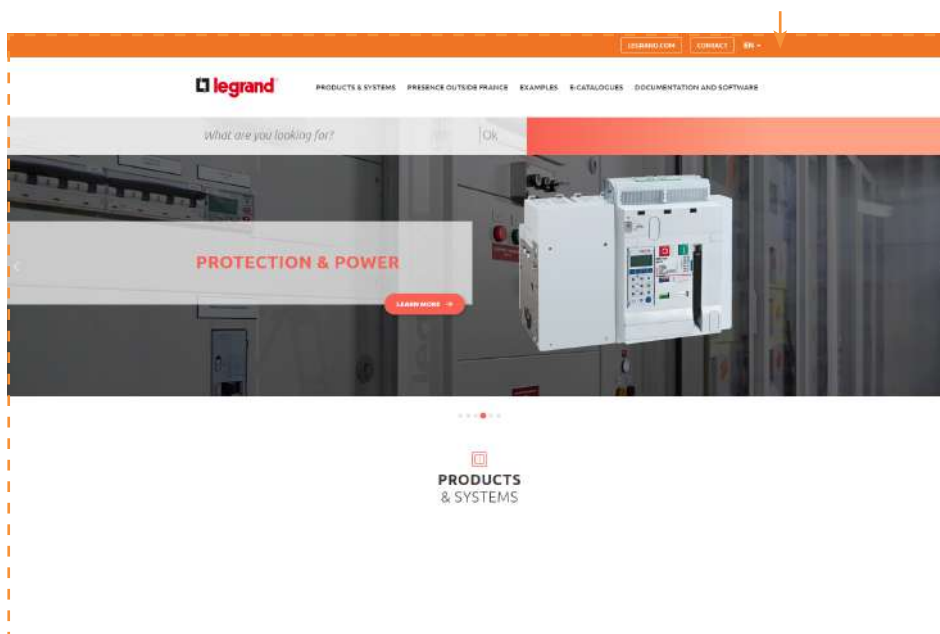

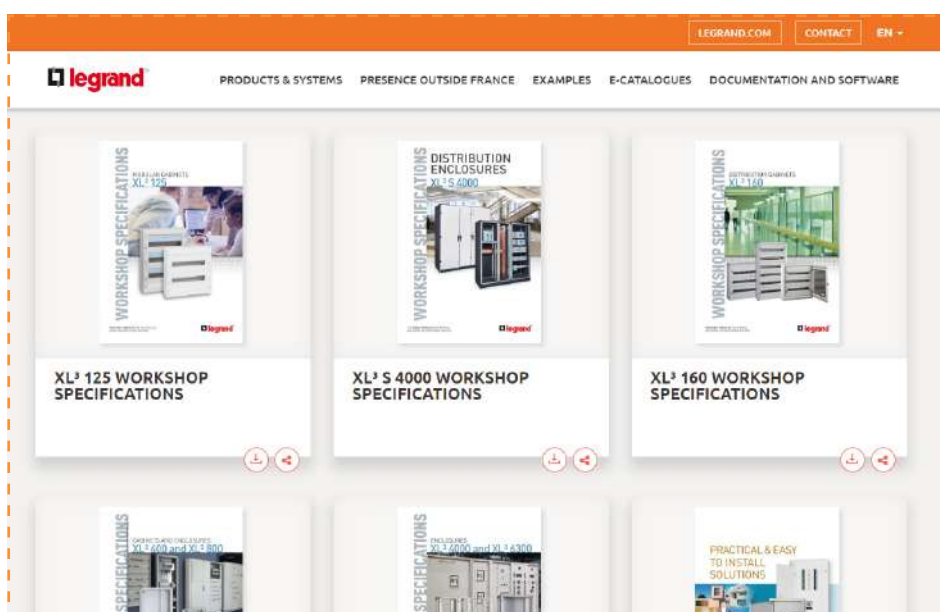

## >DOCUMENTATION





FOLLOW US  
ON

- @ [www.legrand.com](http://www.legrand.com)
-  [youtube.com/user/legrand](https://youtube.com/user/legrand)
-  [twitter.com/legrand\\_news](https://twitter.com/legrand_news)
-  [pinterest.com/legrandgroup](https://pinterest.com/legrandgroup)



**Head office**  
and International Department  
87045 Limoges Cedex - France  
Tel: + 33 (0) 5 55 06 87 87  
Fax: + 33 (0) 5 55 06 74 55