

# VALENA™ LIFE/ALLURE

THE EVOLUTION  
THAT TRANSFORMS  
YOUR DAILY LIFE



CATALOGUE  
PAGES  
INSIDE  
→

THE GLOBAL SPECIALIST  
IN ELECTRICAL AND DIGITAL BUILDING INFRASTRUCTURES

 **legrand**®



Valena Life



Valena Allure

## VALENA LIFE/ALLURE

The evolution  
that transforms  
your daily life

Drawing from decades of know-how, Legrand's Valena range is at once timeless and transformative.

With the Valena range of products and finishes, you can meet the requirements of all your customers.

## INDEX

- Valena Life/Allure - Innovation is in progress	4
- One mechanism two different designs	6
- Valena Life Design	8
- Valena Life - Finishes and colours	10
- Valena Allure Design	16
- Valena Allure - Finishes and colours	18
- Valena Life/Allure - The perfect solution wherever	24
- IN'MATIC: new mechanism and installation advantages	26
- Energy distribution	28
- Switches	32
- Lighting controls	34
- Radio controls	36
- Multimedia solutions	40
- Comfort in every situation	42
- Waterproofness and safety	44
- Valena MyHOME automation	46
- Technology and flexibility in the office	50
- Hotel room management	52
- Catalogue	54

# Valena Life/Allure

# Innovation

is in progress

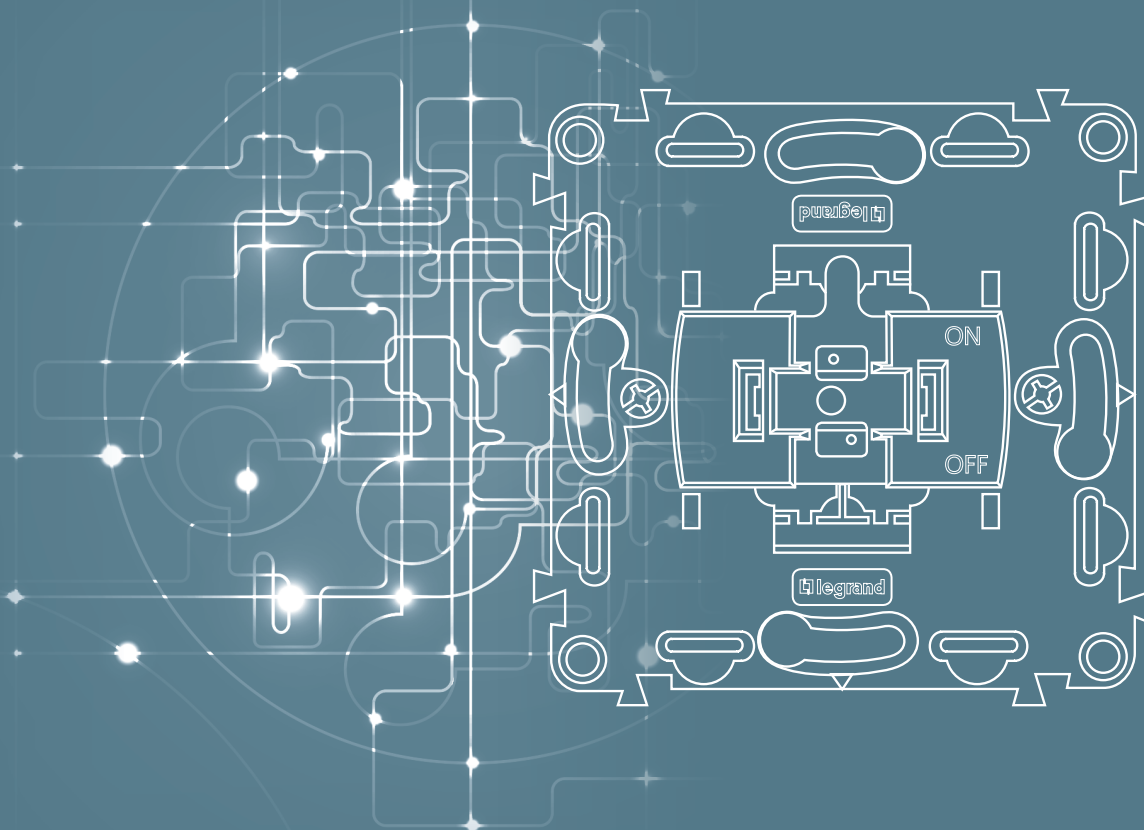

With Valena, Legrand designs new electromechanical and electronic solutions for more and more state of the art systems.

## Valena IN'MATIC mechanism

- Safe
- Reliable
- Performing

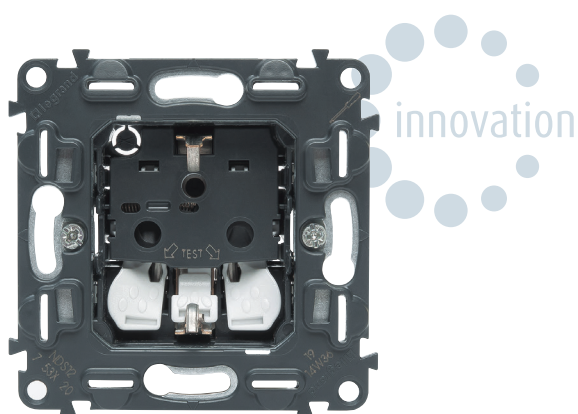

## New functions

- Comfort
- Communication
- Security
- Wireless

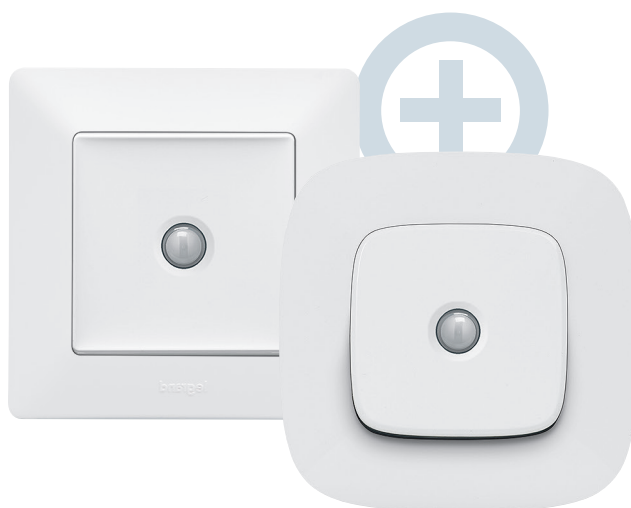

## MyHOME

Automation  
system

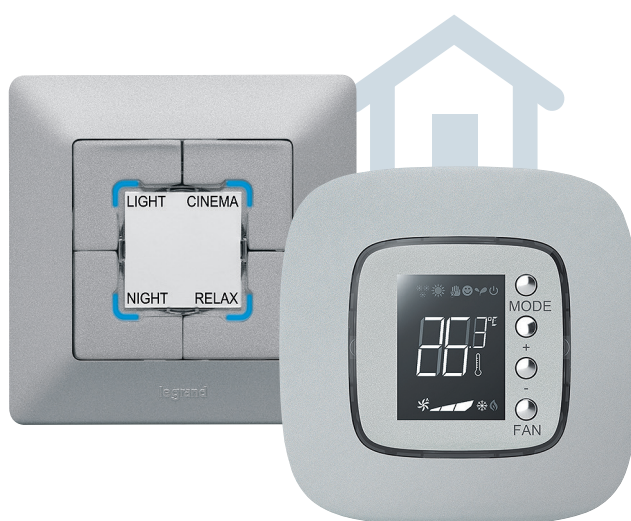

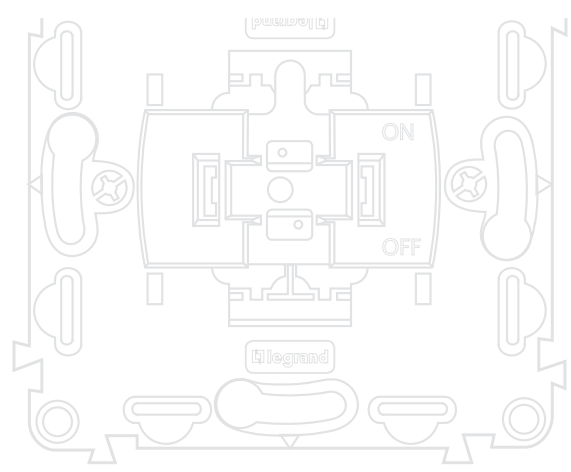

# One mechanism two different designs

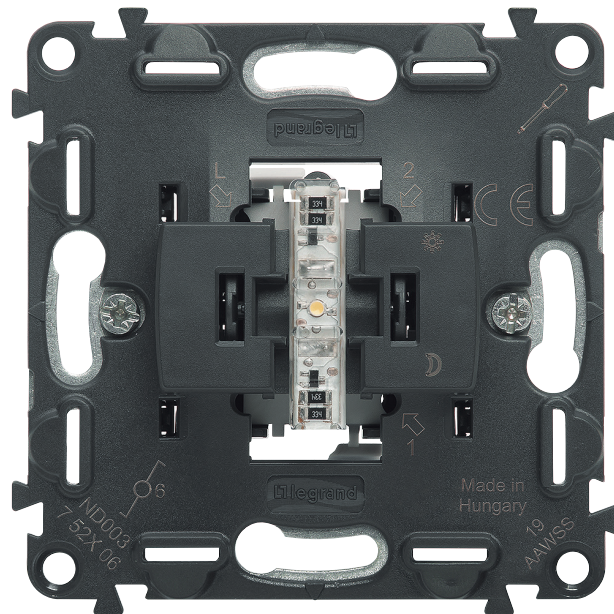

## Valena IN'MATIC

The new Valena Life/Allure range is equipped with the brand new In'Matic mechanism. Valena In'Matic is the result of many years of studies, listening to market demands and true installation tests to make installation and maintenance easier, optimise the electric performance and improve installation comfort.



Valena Life



Valena Allure

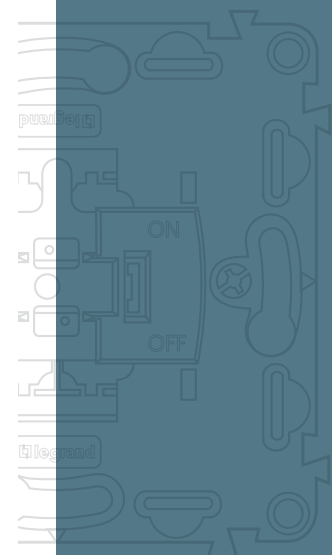

# Valena Life Design

square within  
a square  
**rationalism**  
contemporary  
delicacy  
neutrality

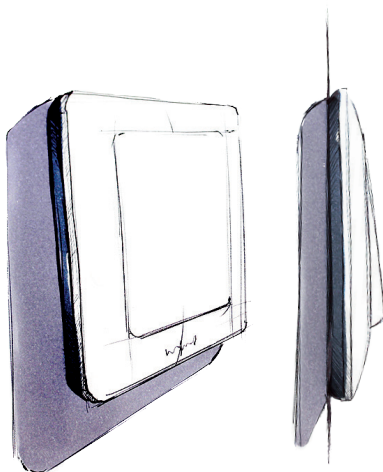
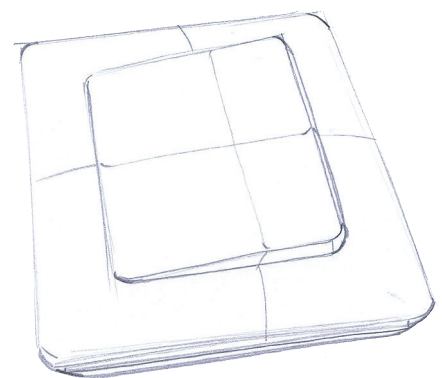

## The importance of details

Valena Life renews itself maintaining its sophisticated style and multiplying innovative solutions.

"The subtle curves of the switch and the delicacy of the lines give lightness to the product. Valena Life's identity lies, above all, in its details."

**Florent Glenisson,**  
designer of the Valena Life / Allure  
range, Legrand Group.







## Lightness at the service of your touch

The modern concave rocker.



## The light side of slimness

The back gives the impression  
that the product is floating  
on the wall.



Valena Life

# Timelessly Classic

Simple. Subtle.  
Finishes that will blend in seamlessly  
in any environment



WHITE



IVORY

PEARL

WHITE-CHROME

IVORY-GOLD

WHITE

Valena Life

# Boldly Expressive

Creative prints and vibrant colours  
add another dimension to every ambience



LINK



Valena Life

# Truly Contemporary

A modern and refined collection that expertly blends the natural with the industrial, from bold to understated – and everything in between



COPPER STYLE



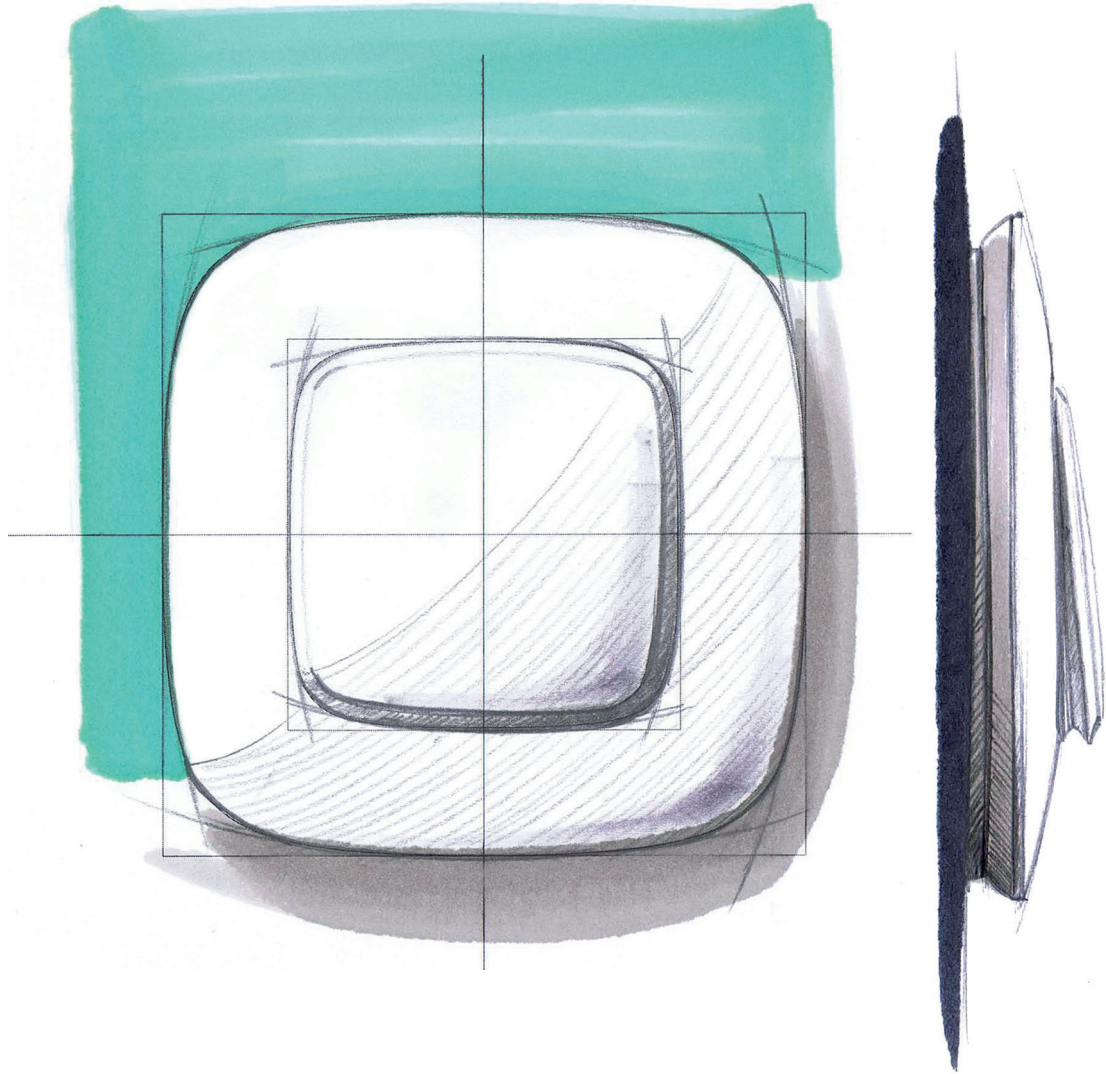

# Valena Allure Design

fresh  
curves  
original  
rupture  
innovative

## An iconic design

"The Valena Allure range represents a real innovation in design and form. Its curves and subtle roundness both seduce the user and endow the product with a lightness and modernity. It represents a true departure from the classic shapes."

**Florent Glenisson,**  
designer of the Valena Life / Allure  
range, Legrand Group.





## Step out of the ordinary

Valena Allure: innovative design can transform the home into an area of new experiences.

## The light

An integrated, subtle and sophisticated light option under the switch allows users to easily locate it even in the dark and give the ambience a technological touch.



Valena Allure

# Tasteful classic

The exquisiteness of the round shapes magnified not only by classic and contemporary colours but also by graceful prints



A bi-material plate,  
with a rounded surface



WHITE

IVORY ZEN

WHITE ZEN

NARCIS CHROME

NARCIS GOLD

FLORA

PEARL

IVORY

ALUMINIUM

MATT BLACK

Valena Allure

# Genuinely elegant

A sight for sore eyes – finishes that blend the delicacy of the chrome or golden surround with noble and refined materials for an unparalleled experience



An interior and exterior metal ring which envelops a refined material, for a noble finish



Golden metal ring



Chrome metal ring

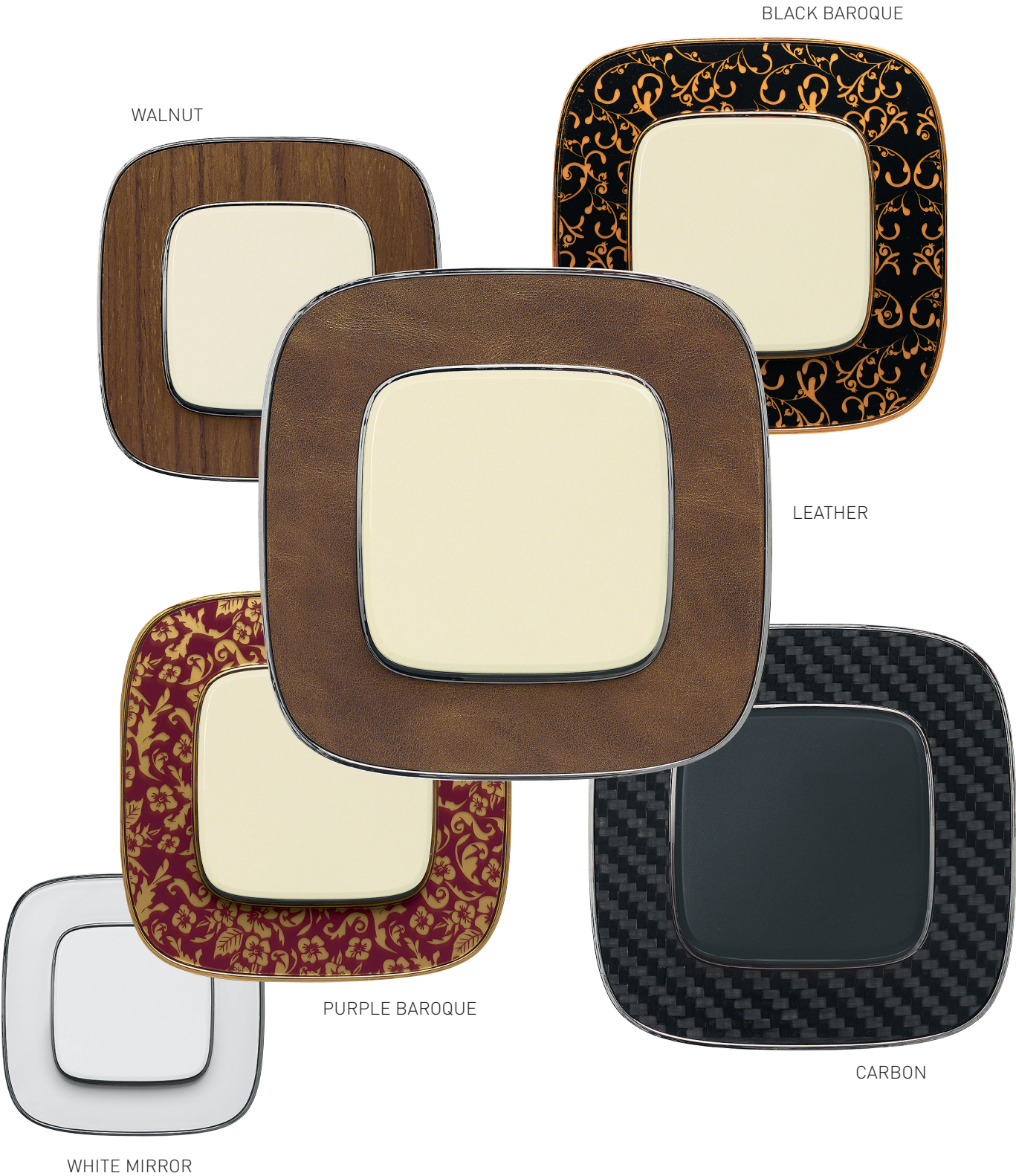

Valena Allure

# Outstandingly unique

A range of sumptuous real materials  
and unexpected inlaid adornments  
for outstanding personalities  
and extravagant interiors



A real material option,  
for your high design,  
high impact interior





# Valena Life/Allure

## The perfect solution wherever

The wide range of functions meets any expectation, and fits with elegance and simplicity in any room of the residential and tertiary sectors.



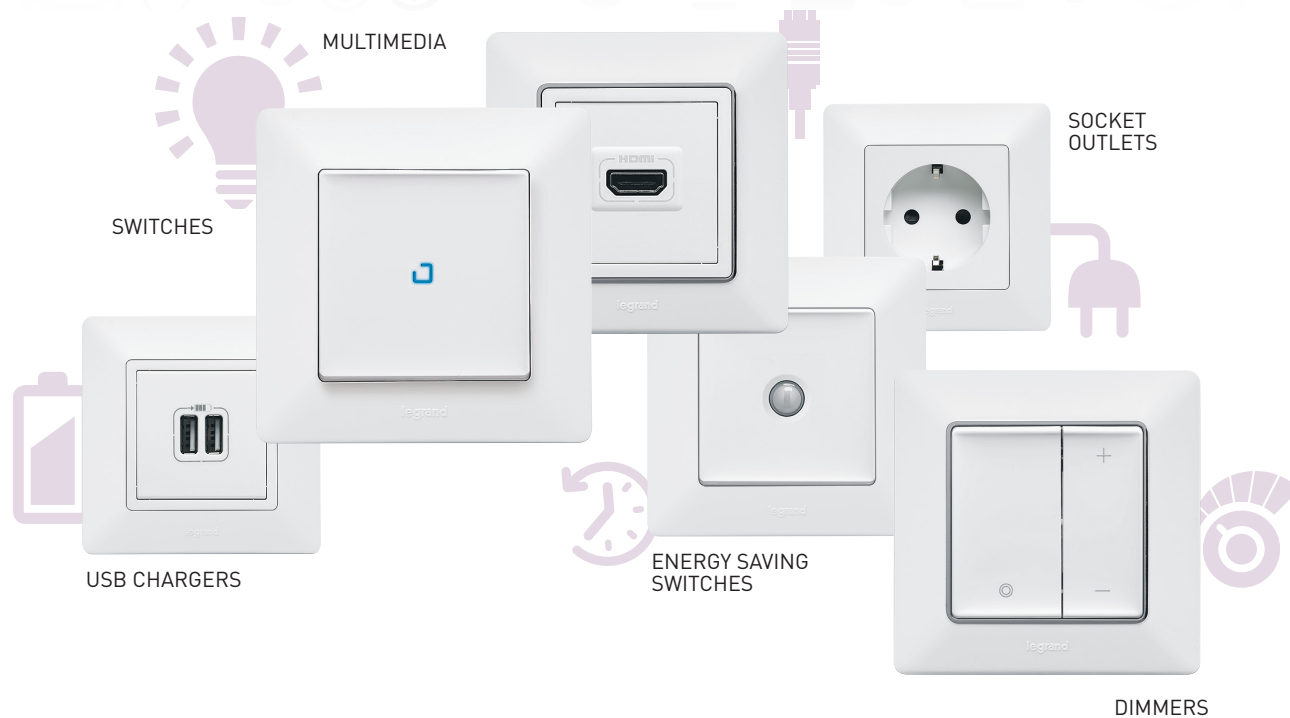

More than 150 functions  
available in the 2 designs  
to fit with elegance  
and simplicity everywhere.

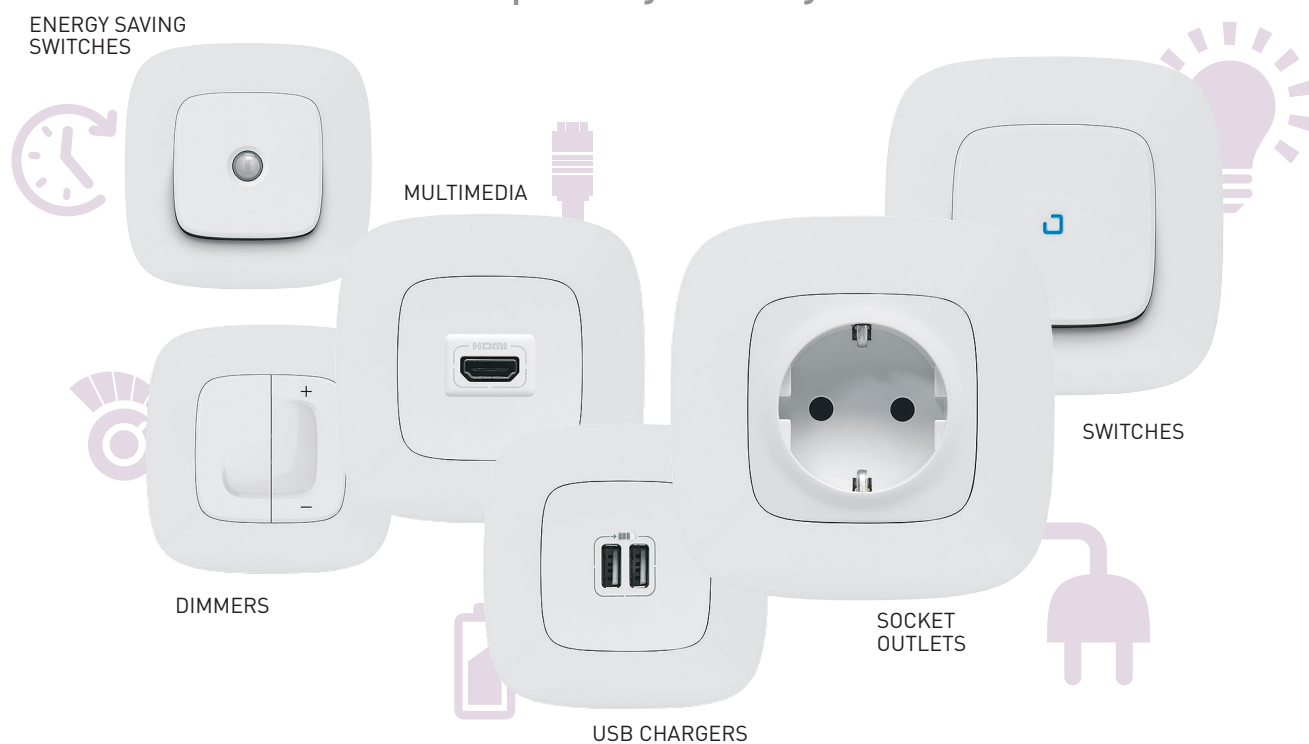

# Valena

# IN'MATIC

## Safe Reliable Robust

### PROTECTED CONTACTS IP2X MECHANISM

No finger contacts with live parts during installation

### BIGGER RELEASE BUTTONS

More comfort for your fingers

### METAL SUPPORT FRAME COVERED BY PLASTIC LAYER

Protection against electrical shock and injuries

innovation

### SHUTTER FOR CHILD PROTECTION

Embedded in the mechanism

### TEST POINTS

Free access without removing the device from the box

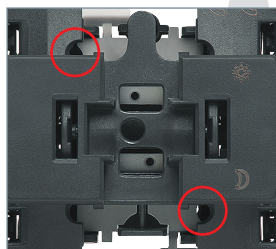

Detail from one-way switch

### Double teeth claw system

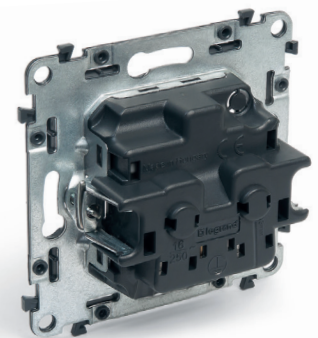

- 1 - More effective grip and better tear resistance
- 2 - Completely protected claws at the neutral position, to avoid damage to the wires and injuries of the hand during installation
- 3 - Fast and automatic return to the neutral position

# IN'MATIC : better performance and maximum quality for sockets and controls

## Automatic terminals with coloured cable entry



**Fast and toolless:** just a few seconds needed to wire the device.  
**Reliable:** longlasting connections guaranteed.  
**Taping off:** faster and easier than with a screw terminal.

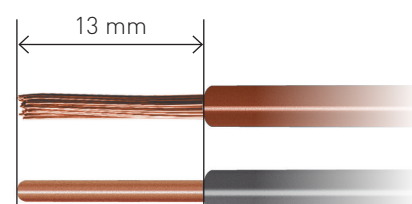
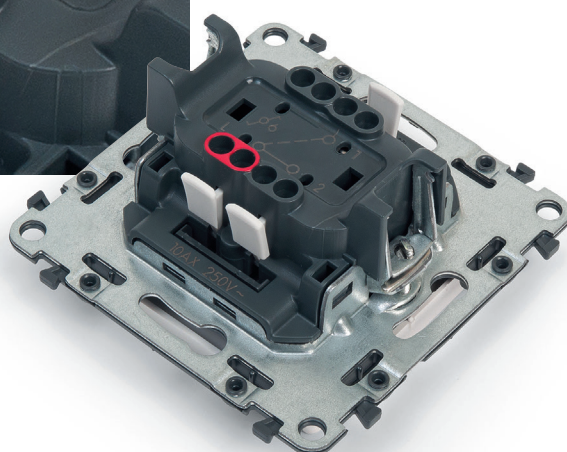

Suitable for both rigid and flexible cable

## Protection cover



Protection of the device against dust, paint and scratches, even after installation. No need to remove the protection when the product is used before the cover plate installation.

## LED Plug-in



Illuminated functions with LED technology: energy saving, longlasting solution.

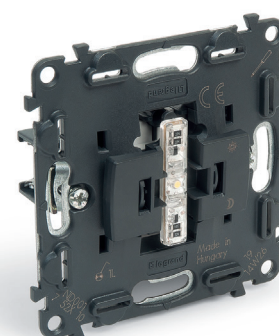

Valena IN'MATIC

# Simple and Faster

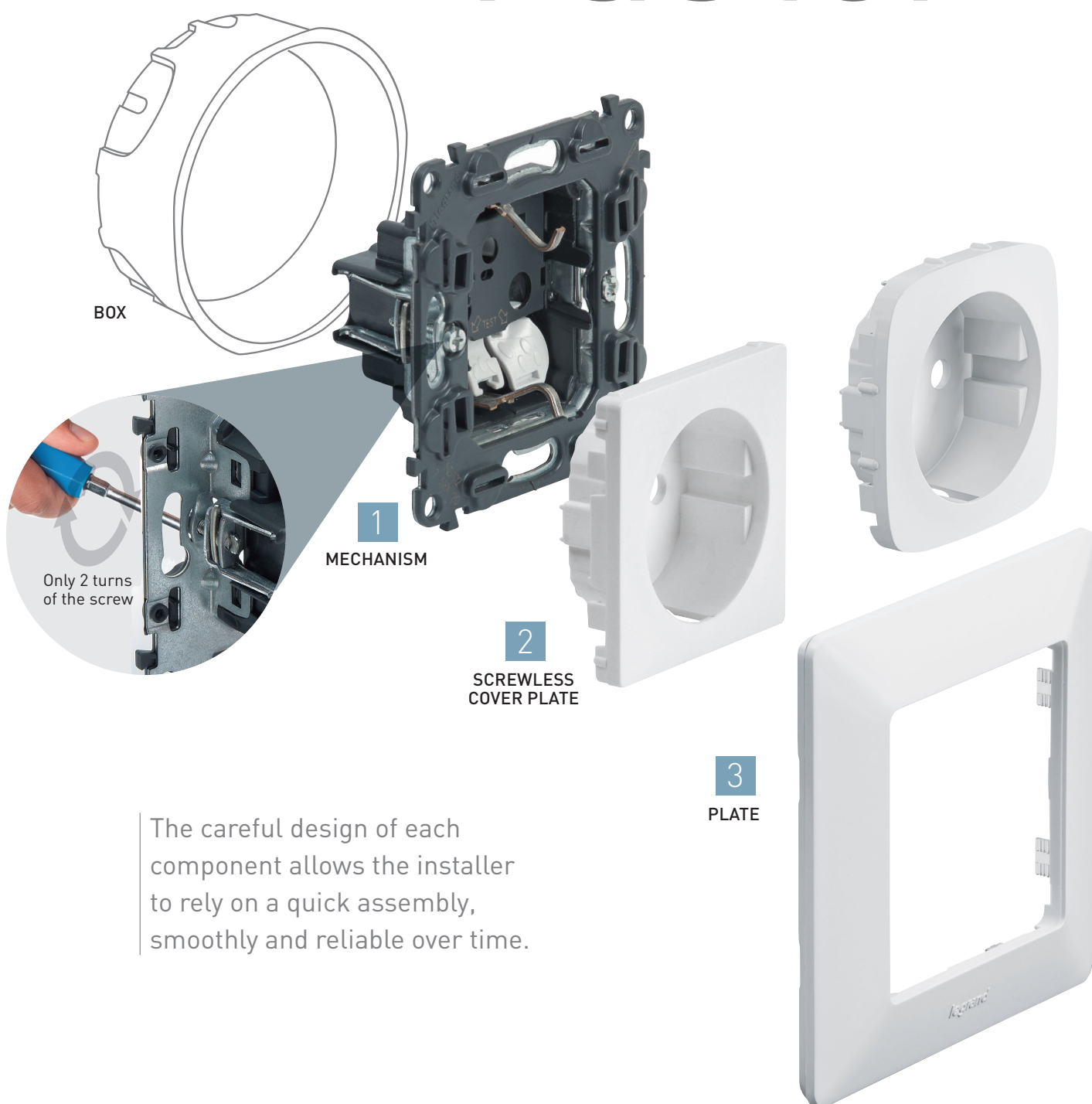

## INSTALLATION PROCEDURE

- 1 Fix the device into the box
- 2 Clip the screwless cover plate into the mechanism (screwdriver not needed)
- 3 Complete the work by clipping the plate. The screwless cover plate guides you in this process



## Innovative docking system for multi-gang installation

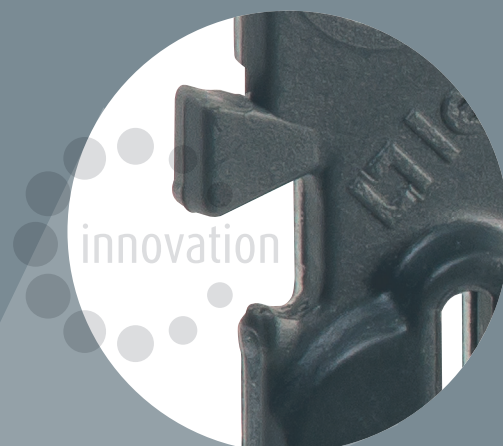

Visual quality of the final seal: perfect alignment of all the products.

Thanks to an innovative docking system, the support frames can be perfectly and easily joined for multi-gang installation.

The new system guarantees the stability and solidity of the devices during assembly: installation of the plastic cover of the mechanism and the cover plate.

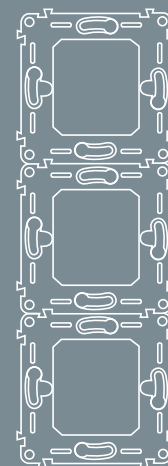

Perfect for installations in both horizontal and vertical orientation.

# Energy

## distribution

A very wide offer  
for new buildings  
and refurbishment

A complete catalogue of 2P+E socket outlets lets you solve all types of high quality domestic and commercial applications.

The socket outlet range features

- automatic terminals: safe and time saving.
- shutters on the mechanism
- testing point on the front face

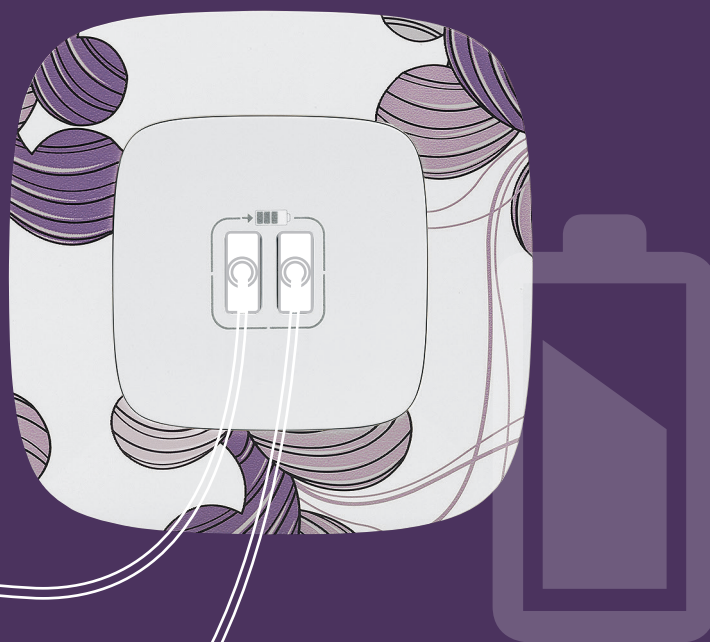

### USB CHARGER

The USB charger can be used to charge mobile phones, smartphones, tablets and similar devices.



**2P+E /USB MIXED SOCKET:  
SAVE SPACE**



Replace a traditional socket by a combination of a 2P+E/USB mixed socket without changing the flush mounting box and the cabling.



**PREWIRED DOUBLE AND TRIPLE SOCKETS**

Only one socket outlet to cable.

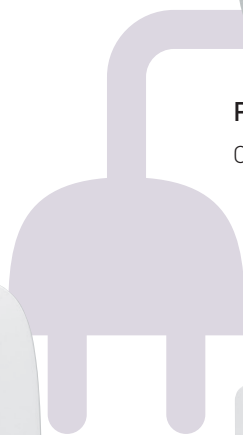
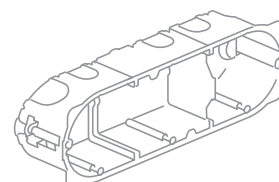

**DOUBLE SOCKET  
OUTLETS**



Fits in one single standard box, saving time and space.



**COLOURED  
SOCKETS**

For specific circuits.



**INDICATOR  
SOCKETS**

All single 2P+E socket mechanisms can become indicator.

# Switches

A complete offer  
for residential  
and commercial  
applications

A broad range  
of solutions to meet  
all your customer  
needs.

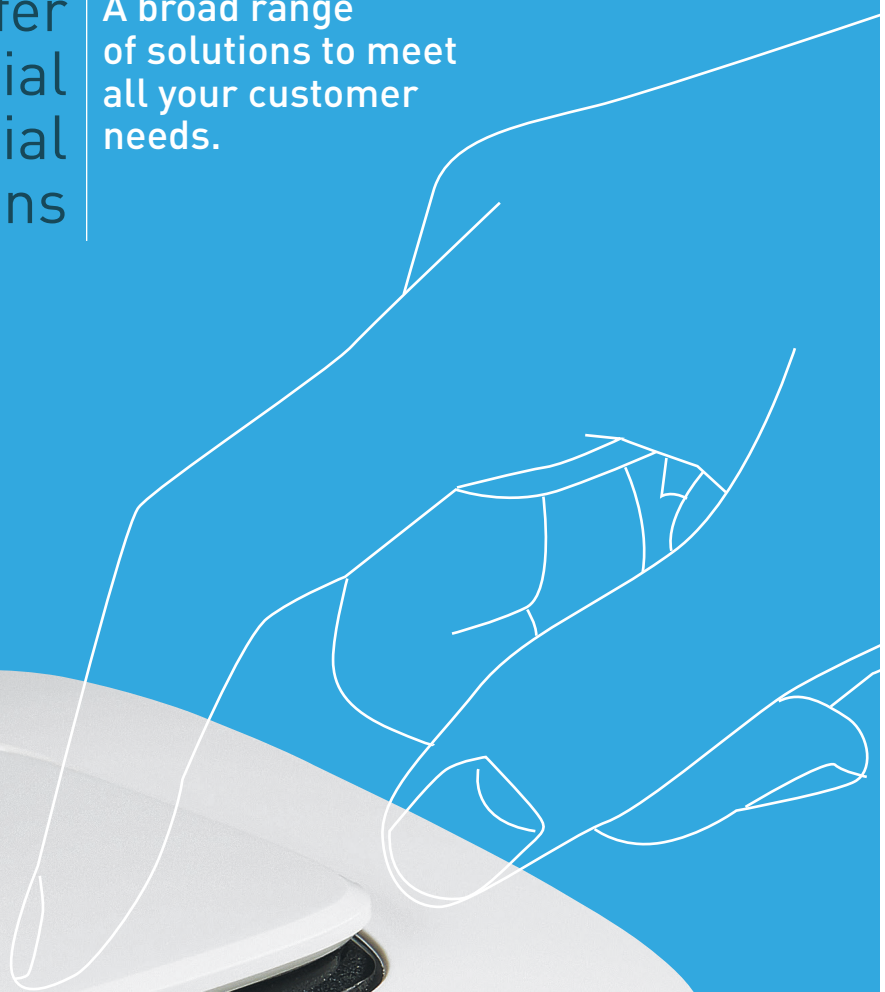

Available in 10AX and 16AX.





**TWO-WAY INDICATOR SWITCH**



**ILLUMINATED TWO GANG TWO-WAY SWITCH**



**PULL CORD CHANGEOVER PUSH-BUTTON**

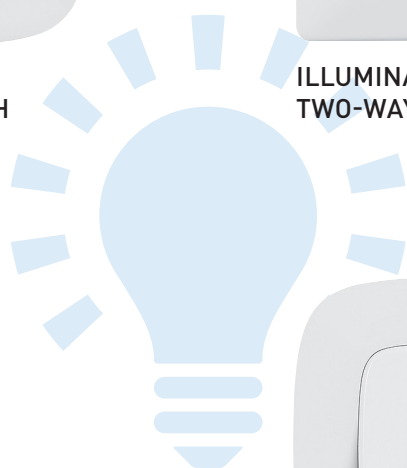

**New multifunction commands: only one device for five functions**

- Two-way switch
- Two gang two-way switch
- Changeover push-button
- Two gang changeover push-button
- Two-way switch / changeover push-button.



**PLUG-IN LED FOR LUMINOUS FUNCTIONS**

Led technology ensures high reliability, long life and energy saving



**VALENA LIFE**

Illuminated and indicator functions with elegant light blue color.



**VALENA ALLURE**

With ALLURE you can create a backlight using dedicated LED. A subtle and innovative light halo is integrated under the rocker.

# Lighting controls

A complete range  
for every kind  
of lamp

Different solutions  
for your comfort, safety  
and energy saving.



#### ENERGY SAVING SWITCH

Is the perfect solution for a child's room, cellar, corridor, etc. The light is switched on by the user and goes off automatically when no one is in the room.

**New dimmers:  
for an efficient  
management of  
all types of load**



**PUSH DIMMER**

2-wire universal dimmer to control and adjust all types of load, LED and CFL included.



**1000W DIMMER\*  
WITH 5 STATUS LED**

Can be associated with push-buttons. Memorises previous light level used.

**Illumination  
only when  
needed**



**MOTION SENSOR**

To manage lighting without waste.



**SKIRTING LIGHT  
WITH MOTION SENSOR**

Light up the path automatically when somebody is passing.



**TIMER SWITCH**

Light off after programmable delay.

\* This function is available only in Valena Life design.

# Radio controls

Light and shutter  
radio controls  
for simple and  
flexible electric  
wiring

Thanks to the radio transmission and the battery powering of controls, the devices easily integrate with the infrastructure of the traditional electric system, without the need for any additional wiring. The use of radio technology (mesh network) for the communication of devices makes it possible to use the solutions in large spaces with obstacles and partition walls.

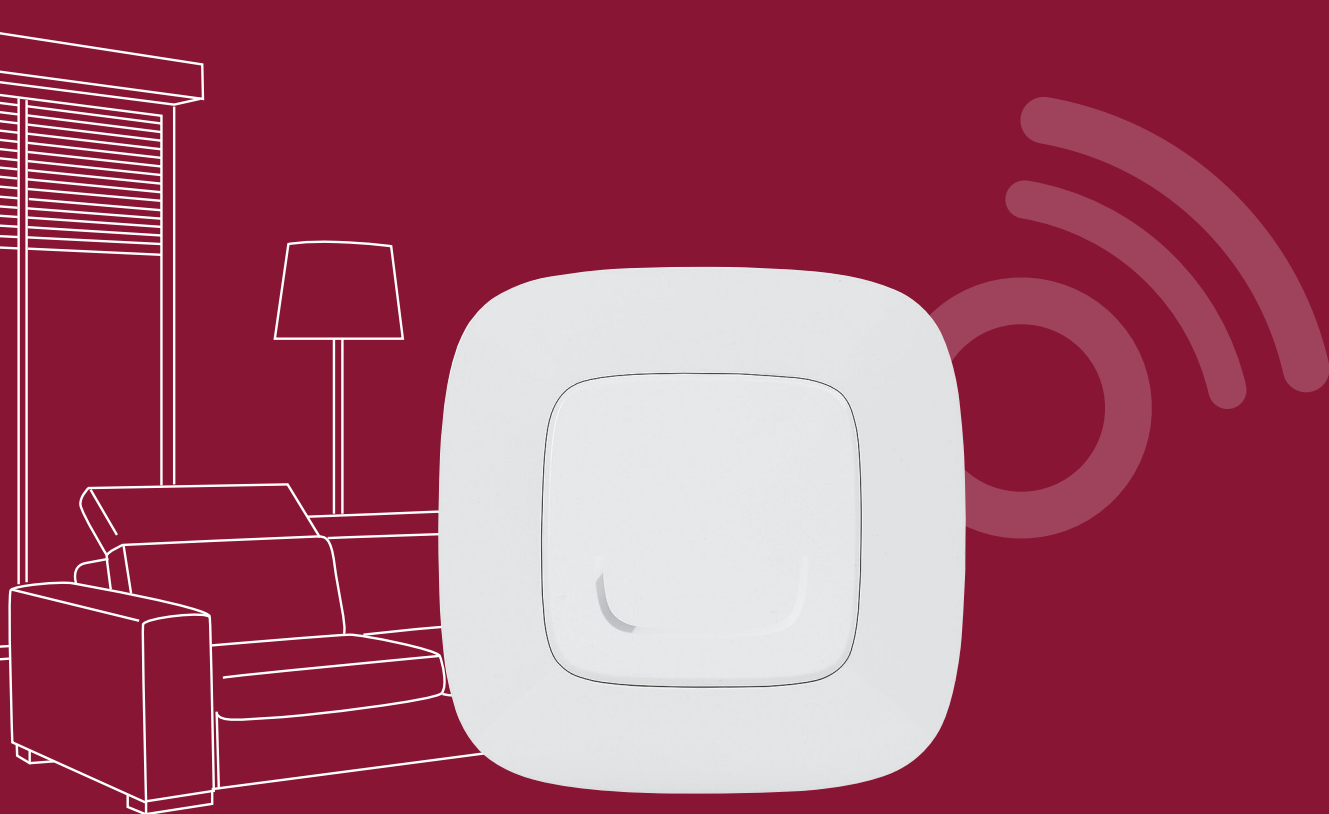

WIRELESS  
CONTROL

# Application for mobile devices.

## Turn the house into a connected home.



MOBILE  
DEVICE APP



RADIO/WI-FI  
GATEWAY



RADIO  
PRODUCT



### THE RANGE IS SPLIT INTO:

- devices to control the load, integrated in the electric system;
- battery operated control devices, installable everywhere in full freedom;
- a radio/wi-fi gateway to let people easily connect to the installation inside and outside the home.



ROLLER BLIND RADIO  
WIRELESS CONTROL



RADIO WIRELESS CONTROL  
FOR TWO LIGHTS



SCENARIO RADIO  
WIRELESS CONTROL

### RADIO TECHNOLOGY

Thanks to the radio technology 2,4GHz, 16 channel, self-healing mesh network the devices in the system do not interfere with wireless devices in the house such as burglar system, computer, network, Wi-Fi data, etc.



### SIMPLE AND QUICK SYSTEM CONFIGURATION

The system configuration does not require tools or software. To include and associate all the devices of the radio network, a simple pressure of the appropriate push-button on the front of each device itself is enough.

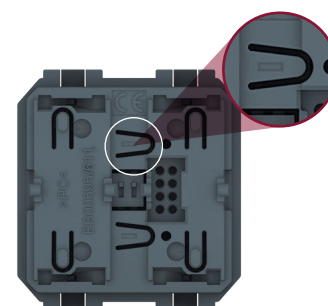

# Radio Controls: Application examples

Addition  
of a second light  
control point

The traditional switch connected to the lamp is replaced by a radio switch without neutral. The radio switch is managed using an ON/OFF radio wireless control installed near the bed.



TRADITIONAL  
SWITCH



RADIO SWITCH  
WITHOUT  
NEUTRAL



WIRELESS  
CONTROL

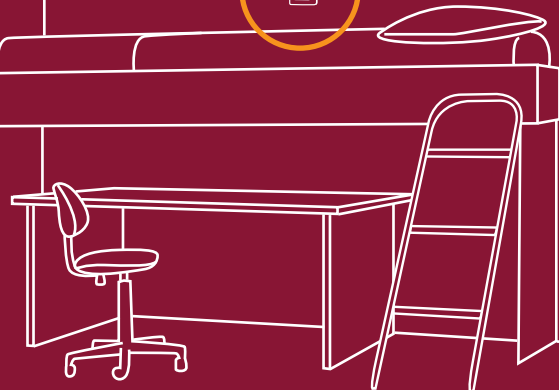
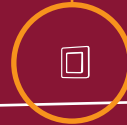
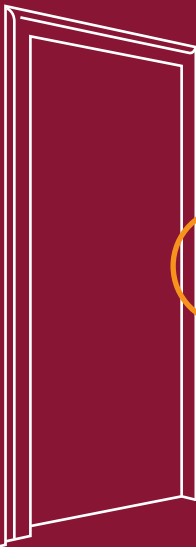



**WIRELESS CONTROL**



**LIGHT MICROMODULE SWITCH**



**WIRELESS CONTROL**

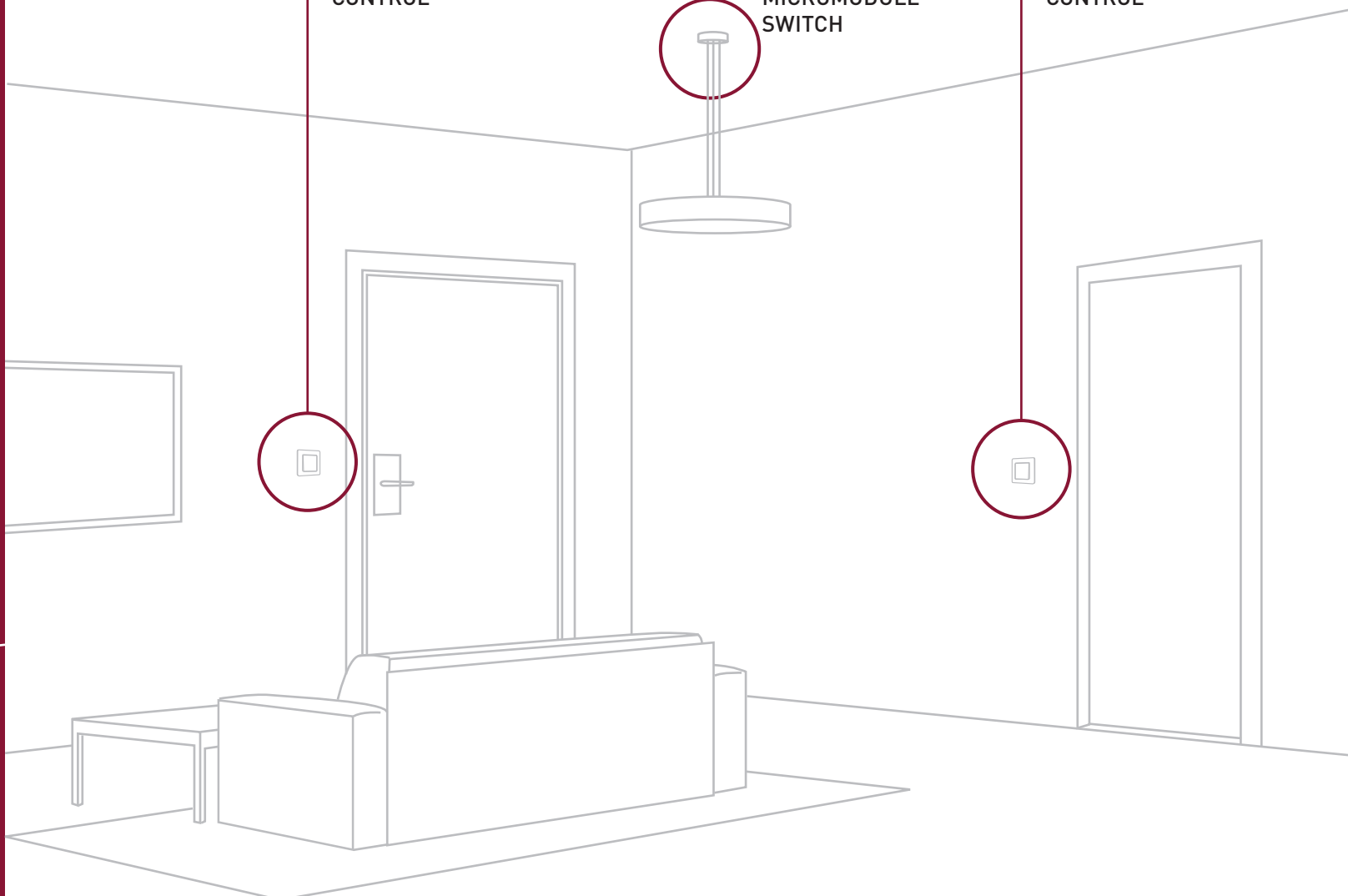

## Creation of a two-way switch

The lighting system can also be made without flush mounted actuators. This is made possible by the use of a special small micromodule switch, which may be easily installed inside the light fitting cup. The switch is managed using wireless radio control installed anywhere inside the room, depending on the user's needs.

# Multimedia solutions

All connections at your fingertips | An easy, flexible and high-quality offer.



## BLUETOOTH MODULE

The Bluetooth module lets you play your smart phone's music, directly through your house's loudspeakers.







## DATA, TV AND AUDIO/VIDEO CONNECTIONS

### AUDIO/VIDEO SOCKETS

CONNECTION, ENTERTAINMENT, AND MULTIMEDIA

A complete range of products dedicated to audio/video connections provides the desired level of entertainment, relaxation and functionality.



TRIPLE RCA SOCKET

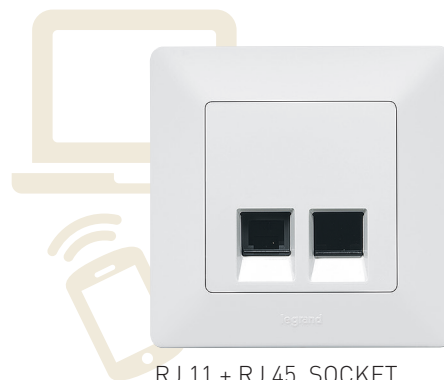

RJ 11 + RJ 45 SOCKET



HDMI 1.3



HD 15 + 3.5 mm JACK

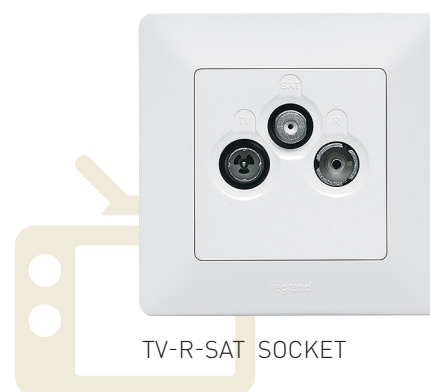

TV-R-SAT SOCKET

## SOUND DIFFUSION SYSTEM

From the 'one-room' solution, to the multi-area complete solution.

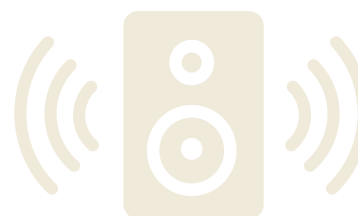

### ONE AREA SOUND DIFFUSION

Easy to install, full integration inside the wall. Tuner or Tuner with display.

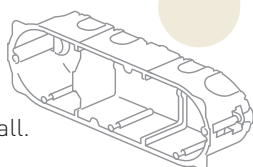

### MULTI AREA SOUND DIFFUSION

The right music in each room. One local control + display by room Intercom possibility.



### LOUDSPEAKER

A wide choice (flush, false ceiling, invisible one).

# Comfort in every situation

Comfort and elegance  
to control domestic  
heating

With Valena control devices,  
you can satisfy all the comfort  
needs of a modern flat or house.

12 08 22.0°C 28  
DAY 1 22.0 23

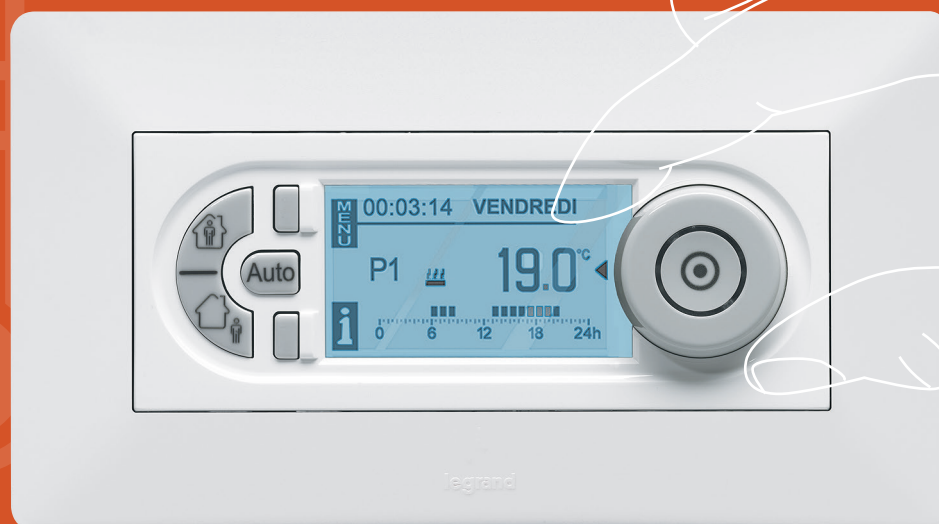

#### PROGRAMMABLE THERMOSTAT

Weekly programming.  
Permanent display  
of the current program.

## MANAGEMENT OF HEATING

Complete offer adapted to every kind of heating system using the same designs as all other wiring devices.



**ELECTRONIC ROOM THERMOSTAT**

To easily control the temperature in every single room.



**FLOOR HEATING THERMOSTAT**

To control the floor's temperature.

## MANAGEMENT OF SHUTTERS

Moves blinds in a practical and effortless way, thanks to its user-friendly ergonomics with intuitive up, down and stop positions.



**ROLLER BLINDS**



**ROLLER BLINDS RADIO SWITCH**

# Waterproofness and **safety**

Valena makes  
your home safer and  
better protected

Flood and gas detectors  
and IP44 functions  
for perfect safety.



**GAS DETECTORS\***

For methane

## TECHNICAL ALARMS\*

Protection of the home against water and gas leaks with the same design as all other wiring devices.



**GAS DETECTORS**  
For propane/butane.



**WATER LEAK DETECTOR**

## IP44 PROTECTION\*

A complete weatherproof range whenever an IP 44 protection index is required.

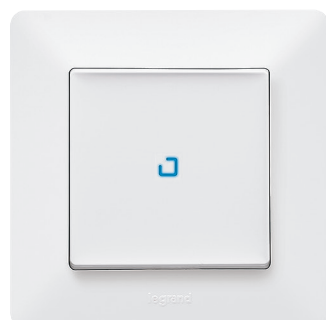

**LIGHTING CONTROL**



**MOTION SENSOR**



**IP44 PLATE**  
To make all the In'matic mechanisms IP44.

\* All the function belonging to the Technical Alarm and IP44 protection range are available only in Valena Life design.

# Valena™

## MyHOME® automation

Thanks to a wide range of devices, MyHOME offers simple and efficient solutions to meet the safety, comfort, energy and communication needs of any private home and service sector establishment. Thanks to intelligent and programmable electronic devices, MyHOME makes it possible to access, in a simple and customised way, advanced functions that would

be difficult in a traditional electric system.

In addition, its installation modularity and the functional integration of the various devices offer freedom to decide which applications to install immediately, and which in the future, without the need for important structural updates, and with highly effective cost management.

MyHOME can also be integrated with other systems, such as KNX and DALI. Using the appropriate interface, and the TCP/IP protocol, MyHOME is capable of managing and supervising the home also remotely, using a fixed telephone line, a mobile phone, or an internet connection.



### MyHOME\_SCREEN10

Thanks to the 10" 16/9 touch screen, users can manage and control the electric system, the multimedia functions (photos, audio, video), and the Internet connection.

POWER SUPPLY

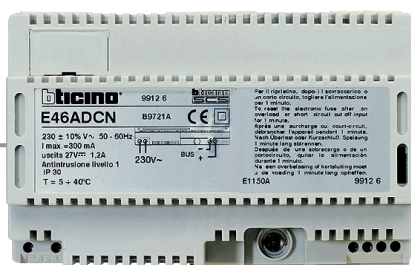

# Functions

## COMFORT

- Light automation
- Management of shutters and automations
- Scenario activation

THERMOSTAT



LIGHT CONTROL



2-WIRE BUS

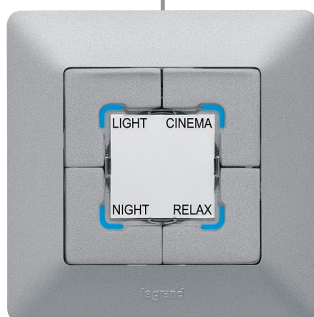

SCENARIO CONTROL



LIGHT AND SHUTTER CONTROL



8-KEY CONTROL



Device for remote control of the functions.



Internet

# Valena™ MyHOME® automation

## Functions



### ENERGY MANAGEMENT

- Temperature control
- Air conditioning
- Load management
- Consumption display



**TEMPERATURE PROBE**

With display



**CONSUMPTION DISPLAY**  
MyHOME\_SCREEN 10

### Produced energy measurement

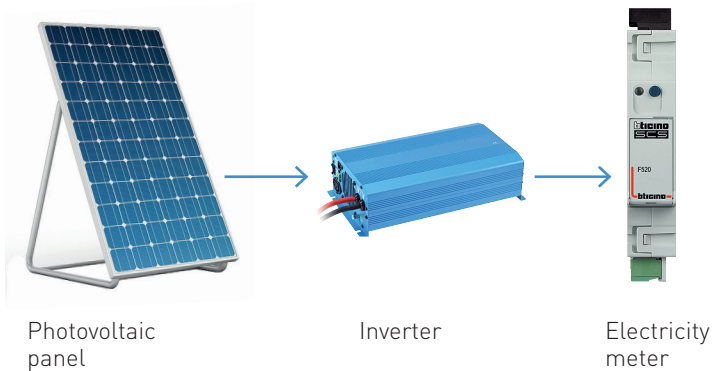

### Energy consumption measurement

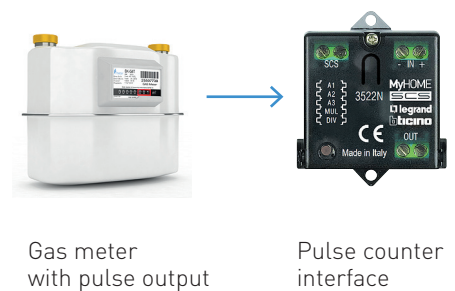



## SUPERVISION AND MONITORING

MyHOME provides supervision and monitoring of the integrated functions in the home in total safety and discretion. Control can be remote and local. Remote control

is through a PC, hand held computer, telephone or mobile phone, using the Internet connection and the potentialities of the Web platform. Local using a simple control,

or an advanced device like the MyHOME\_SCREEN 10 touch panel or a tablet with the MyHome Legrand application installed, which can be downloaded free of charge.

### Remote control

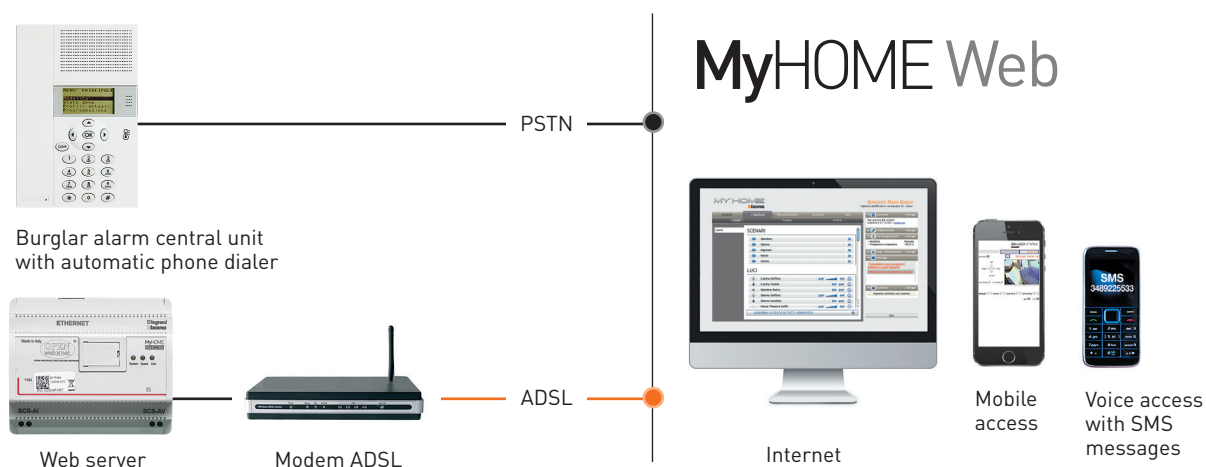

### Local control



MyHOME\_SCREEN 10"



TABLET

With MyHome BTicino application.

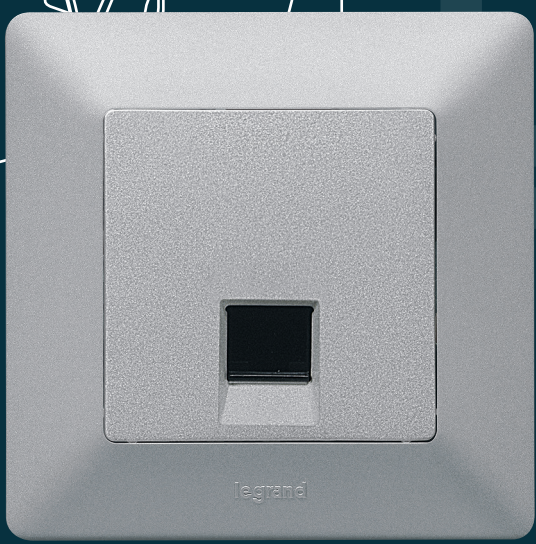

NEW RJ45 TOOLLESS CONNECTORS



USB CHARGER

# Technology and flexibility in the office

“Nomadic” working practices and the constant desire to optimize productivity are influencing the way in which office buildings are designed. An infrastructure is therefore needed for flexible installation of electrical equipment and communication networks at the desired point.



## Flush workstation for commercial buildings

Make the most of the 200 Mosaic functions with Valena Life aesthetics for a functional and compact workstation solution.

### SPECIAL 8 MODULE AND 2x8 MODULE SUPPORTS\*

With Valena Life plate available in white and aluminium versions.



### 1000W DIMMER\*

For commercial buildings, with 5 status LED.

## Automation system



The Valena offer includes devices which conform to the KNX international standard, which is the most widely used technology for the intelligent management of buildings.

#### MAIN APPLICATIONS:

- Lighting control
- Shutter/slat controls



### CONTROL KNX

With aesthetic lighting.

\* This function is available only in Valena Life design.

# Hotel room management

A complete offer for a state of the art electric system in the hotel room as well

The Legrand Hotel range has been designed for a pleasant hotel stay, making guests feel as if they were in their own homes.



**"DO NOT DISTURB - MAKE UP ROOM"  
LAMP WITH DIFFUSER, DOORBELL AND  
READER FOR ACCESS CONTROL FUNCTION**



**INSIDE THE ROOM:  
"DO NOT DISTURB -  
MAKE UP THE ROOM"  
PUSHBUTTONS,  
AND KEY CARD SWITCH**

## Immediately at ease

The presence of a key card switch invites the guest to immediately interact with the room services on offer. To be left undisturbed simply press the "do not disturb" control.

## Connection, entertainment, and multimedia

A range of products dedicated to audio/video connections provides the desired level of entertainment and relaxation.

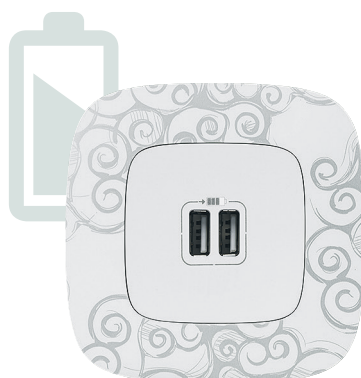

**USB CHARGER**



**HDMI CONNECTOR**

To manage readers and electronic devices such as DVDs, digital cameras and MP3 readers.



**MyHOME DIGITAL THERMOSTAT**



**MyHOME 8-KEY CONTROL**

## The right atmosphere, in one move

Thanks to the new MyHOME device control with 8 keys (customisable) and digital thermostat installed at the side of the bed, you can recreate the desired atmosphere with a single touch, adjusting the light, temperature and shutter.



## Extra attention to safety

Skirting light with motion sensor for the night, alarmpull cords and sockets to ensure maximum safety at all times.



## Supervision software

To control the status of the rooms with the corresponding notifications, and manage the available functions. It also performs functions connected with programming the keycards.

- 2 TYPES OF SOFTWARE AVAILABLE:
- Management of up to 20 rooms or common areas
  - Management of over 20 rooms or common areas

